

**RONDO  
DONN®**



**EXPOSED GRID  
CEILING SYSTEM**

**RONDO®**

## STANDARDS AND BUILDING CODES

Rondo Building Services uses the following Standards in its manufacturing, testing and marketing policies for compliance with the respective Building Codes of Australia and New Zealand:

- AS/NZS 2785 Suspended Ceilings, Design and Installation
- AS 1397 Continuous hot-dip metallic coated steel sheet and strip – Coatings of zinc and zinc alloyed with aluminium and magnesium
- AS/NZS 4600 Cold Formed Steel Structures Code
- AS/NZS 1170 Structural Design Actions
- AS 1170.4 Earthquake Loads (Australia)
- NZS 1170.5 Earthquake Loads (New Zealand)
- NZS 4219 Specification for Seismic Resistance of Engineered Systems in Buildings
- NZBC–  
B1/VM1 NZ Building Code Verification Method B1/VM1 Clause 2
- NZBC –  
B2 Durability Rondo DONN® 24 and 15mm Systems will have a minimum serviceable life of 15 years when installed in a dry, non-corrosive, interior installation

# RONDO DONN® EXPOSED GRID CEILING SYSTEM

## INTRODUCTION

The Rondo DONN® Exposed Grid Ceiling System includes the popular 24mm face grid and the more slimline 15mm face grid option to give designers an alternative grid appearance and installers a system they already know.

The well-known DONN® Quick Release Clips (QRC) are located on the ends of Rondo DONN® Cross Tees to enable fast and easy installations without the need for mechanical tools or fixing.

Transitions between exposed and concealed grid ceilings are also made possible with Rondo DONN® Grid Ceiling System being fully compatible with our Rondo XPRESS® Drywall Grid Ceiling System.

## UNIQUE FEATURES

- Quick Release Clips – high tensile, allows for quick and easy installations
- Lay-on Cross Tees resist twist and gapping
- During installation, Cross Tees can be cantilevered and will not drop out due to their positive connections
- Positive lock between Main Tee and Cross Tee is achieved without the need for mechanical tools or fixing
- The DONN® 15mm Cross Tees include a patented centering device in the QRC Tab to ensure rebated and square edge Acoustic Panels are installed square
- The DONN® 24mm Cross Tees come in three heights (38mm, 32mm and 24mm), two gauges (standard and heavy duty) and in white as standard, with black also available on enquiry

## IMPORTANT NOTES:

***Rondo recommends its products and systems are installed by a qualified tradesperson and according to the relevant codes and standards. Rondo recommends that before acting on any advice or opinion in this manual, you should seek professional advice in light of your own architectural and building requirements.***

***SEISMIC DESIGN: Reference is made in this manual to seismic specific components of the Rondo DONN® System. For seismic specific design specifications and advice, please speak with a Rondo Technical Representative.***

## CONTENTS:

### COMPONENTS 2

#### PRODUCT DATA SPECIFICATIONS

24mm FACE GRID SYSTEM 4

15mm FACE GRID SYSTEM 5

#### TYPICAL APPLICATION DETAILS

GRID SYSTEM COMPONENTS 6

WALL ANGLES 7

TRANSITION & SPLICE CLIPS 9

JOINING & RETENTION CLIPS 10

#### INSTALLATION DETAILS

LIGHTING INSTALLATION 11

REQUIREMENTS &

GOOD DESIGN PRACTICES 14

#### TRANSITION TO THE RONDO XPRESS® DRYWALL GRID SYSTEM 18

TYPICAL APPLICATION 19

TRANSITION CLIP 20

#### GRID CONFIGURATIONS & LOAD TABLES

RONDO DONN® 24mm SYSTEM 22

RONDO DONN® 15mm SYSTEM 26



# RONDO DONN® SYSTEM COMPONENTS

## PRIMARY SECTIONS: 24mm GRID SYSTEM

DX1	38mm (h) x 24mm (face) Main Tee
DX1H	38mm (h) x 24mm (face) Heavy Duty Main Tee
DX2	38mm (h) x 24mm (face) Cross Tee
DX2H	38mm (h) x 24mm (face) Heavy Duty Cross Tee
DX3	32mm (h) x 24mm (face) Cross Tee
DX4	25mm (h) x 24mm (face) Cross Tee
DXB	38mm (h) x 24mm (face) Black Cap Main Tee
DXBM	32mm (h) x 24mm (face) Black Cap Cross Tee
DXBS	25mm (h) x 24mm (face) Black Cap Cross Tee

## PRIMARY SECTIONS: 15mm GRID SYSTEM

DC1S	38mm (h) x 15mm (face) Main Tee
DC1H	38mm (h) x 15mm (face) Heavy Duty Main Tee
DC2S	38mm (h) x 15mm (face) Cross Tee
DC2H	38mm (h) x 15mm (face) Heavy Duty Cross Tee

## WALL ANGLES

WADX	22mm (h) x 19mm (w) Steel Wall Angle
WAH	22mm (h) x 19mm (w) Heavy Duty Steel Wall Angle
WAL	40mm (h) x 19mm (w) Long Leg Steel Wall Angle
WASA	15mm (h) x 10mm (w) x 10mm (h) x 12mm (w) Shadow Line Steel Wall Angle
WASL	27mm (h) x 10mm (w) x 10mm (h) x 19mm (w) Shadow Line Long Leg Steel Wall Angle
WAS	42mm (h) x 26mm (w) x 22mm (w) Seismic Steel Wall Channel
WAC	22mm (h) x 14mm (w) Steel Wall Angle (for DONN 15mm Grid System)
WAB	22mm (h) x 19mm (w) Black Steel Wall Angle
SA12	40mm (h) x 40mm (w) Seismic Steel Wall Angle

## PRIMARY SECTIONS: 24mm GRID SYSTEM

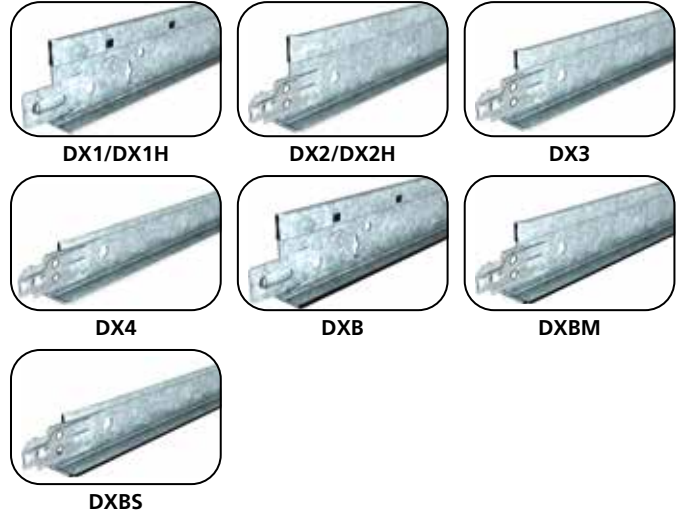

## PRIMARY SECTIONS: 15mm GRID SYSTEM



## WALL ANGLES



### SUSPENSION CLIPS, BRACKETS, RODS & WIRE

247	60mm (h) x 25mm (w) x 21mm (l) Bracket – 121 Rod to Masonry/Concrete
274	80mm (h) x 25mm (w) Bracket – 121 Rod to Timber/Steel
534	110mm (h) x 38mm (w) Adjustable Suspension Bracket – 121 Rod to Timber/Steel
547	78mm (h) x 38mm (w) Adjustable Suspension Bracket – 121 Rod to Masonry/Concrete
719	Adjustable Suspension Clip – M6 Thread – Hooked – suits 121 Rod
DXCL	Spring Adjustable Clip for 5mm Soft Galv Suspension Rod or Ø2.5mm Soft Galv Wire
DXDF	Direct Fix Strap
121	Ø5mm Soft Galvanised Suspension Rod
120	Ø2.5mm Soft Galvanised Wire

### JOINERS

XDSC	Splice Clip – 180°
XD10	Transition Clip – 90°
XD11	Transition Clip – Rondo DONN® to Rondo XPRESS®
XD16	Main Tee Separation Joint Clip
XD19	Strongback Clip
XD20	DX Tee Face Sleeve
XD35	Seismic Expansion Joint Clip
XD36	3-Way Off-Module Connector

### RETENTION CLIPS

XD17	Seismic Clip – Grid to Wall Angle
703	Tile Hold-Down Clip for 10mm to 16mm tiles

### DELIVERY, STORAGE & HANDLING

- All materials shall be delivered in their original, unopened packages.
- All materials shall be stored for as short a time as possible in an enclosed shelter that provides protection from exposure to the elements.
- Damaged, deteriorated or faulty material is not to be installed and shall be removed from the premises.
- Materials should be handled in such a manner as to prevent damage, including racking distortion or physical damage.

### SUSPENSION CLIPS, BRACKETS & RODS



### JOINERS



### RETENTION CLIPS

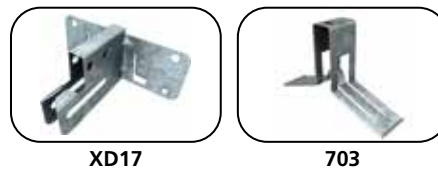

# PRODUCT DATA SPECIFICATIONS

## RONDO DONN® 24mm GRID SYSTEM

### DX1 MAIN TEE

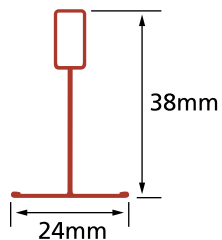

PART NO	LENGTH (mm)	HEIGHT (mm)	WIDTH (mm)	GAUGE (BMT)
DX1	3600	38	24	0.30
DX1H	3600	38	24	0.39

### DX2 CROSS TEE (DEEP)

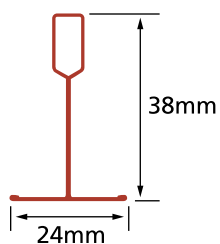

PART NO	LENGTH (mm)	HEIGHT (mm)	WIDTH (mm)	GAUGE (BMT)
DX2	600	38	24	0.30
DX2	1200	38	24	0.30
DX2H	1200	38	24	0.39

### DX3 CROSS TEE (MEDIUM)

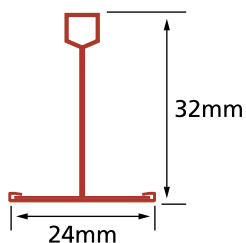

PART NO	LENGTH (mm)	HEIGHT (mm)	WIDTH (mm)	GAUGE (BMT)
DX3	1200	32	24	0.30

### DX4 CROSS TEE (SHALLOW)

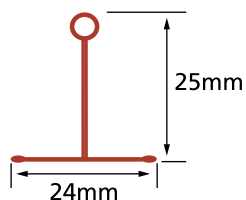

PART NO	LENGTH (mm)	HEIGHT (mm)	WIDTH (mm)	GAUGE (BMT)
DX4	600	25	24	0.30

## RONDO DONN® 15mm GRID SYSTEM

### DC1 MAIN TEE

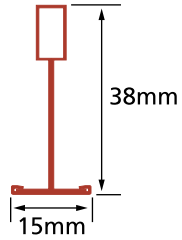

PART NO	LENGTH (mm)	HEIGHT (mm)	WIDTH (mm)	GAUGE (BMT)
DC1S	3600	38	15	0.30
DC1H	3600	38	15	0.39

### DC2 CROSS TEE

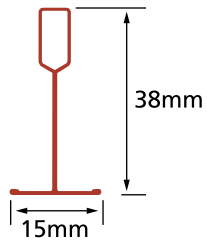

PART NO	LENGTH (mm)	HEIGHT (mm)	WIDTH (mm)	GAUGE (BMT)
DC2S	1200	38	15	0.30
DC2H	1200	38	15	0.39



# TYPICAL APPLICATION DETAILS

Grid System Components (for component part numbers see pages 2 & 3)

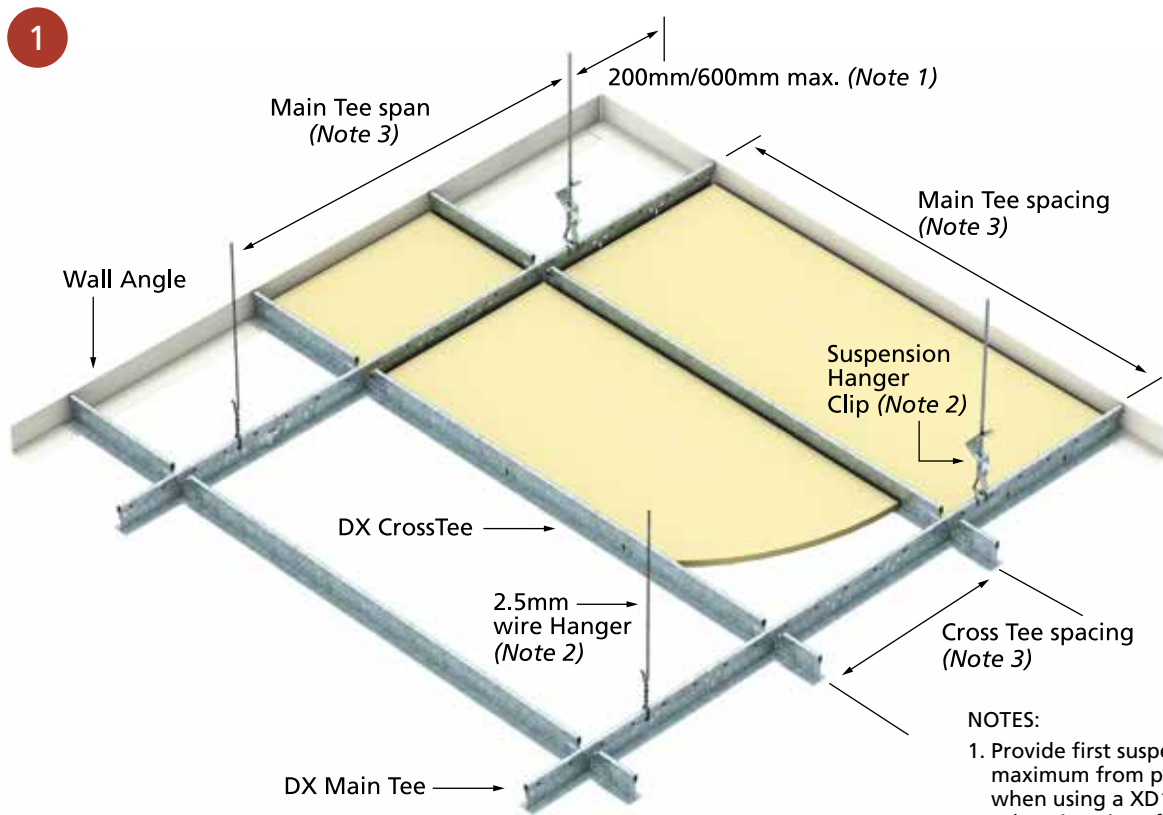

■ RONDO DONN® 24mm GRID SYSTEM

**NOTES:**

1. Provide first suspension at 600mm maximum from perimeter wall when using a XD17 clip. For all other situations first suspension point is 200mm maximum.
2. Suspension shown is indicative only. Rondo does not recommend mixing of suspension systems within the ceiling grid. Refer to design tables for grid suspension capacity.
3. Refer to the Ceiling Grid Design Tables for Main Tee and Cross Tee span and spacing.

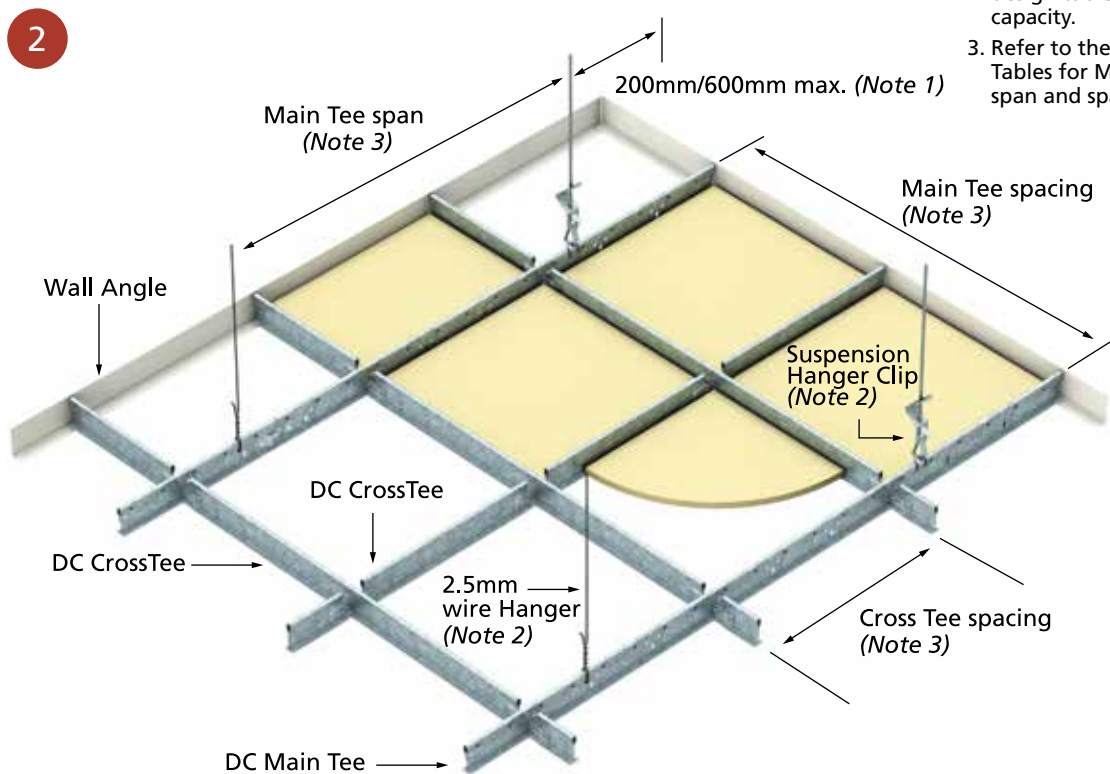

■ RONDO DONN® 15mm GRID SYSTEM



## Wall Angles

NOTE: Trim to be fixed to wall, max 600mm centres. Fixing to be relevant to wall strata (e.g. plug & screw or suitable fixings). Seismic requirements may take precedence of type and quantity of fixings.

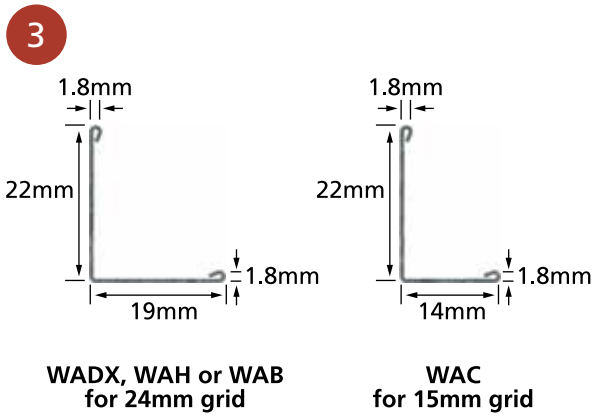

■ STANDARD WALL ANGLES



■ STANDARD WALL ANGLE APPLICATION

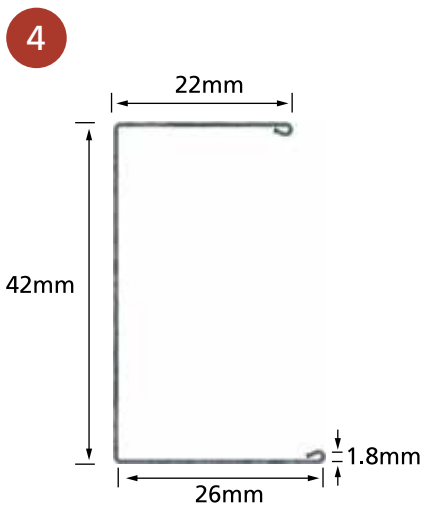

■ SEISMIC WALL ANGLE - WAS

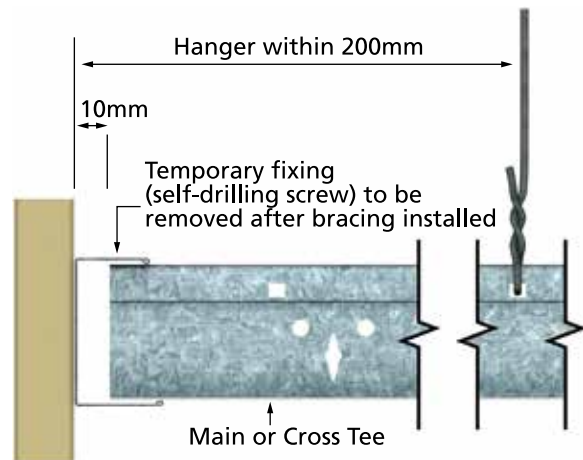

■ SEISMIC WALL ANGLE APPLICATION

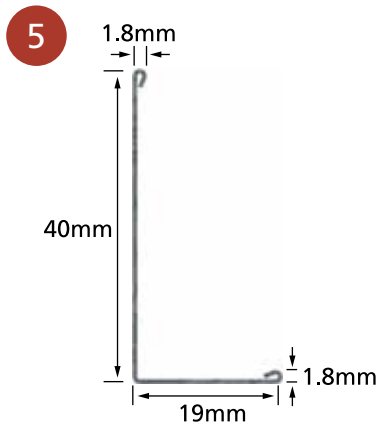

■ WAL LONG LEG WALL ANGLE - WAL



■ LONG LEG WALL ANGLE TYPICAL APPLICATION

# TYPICAL APPLICATION DETAILS (continued)

## Wall Angles

NOTE: Trim to be fixed to wall, max 600mm centres. Fixing to be relevant to wall strata (e.g. plug & screw or suitable fixings). Seismic requirements may take precedence of type and quantity of fixings.

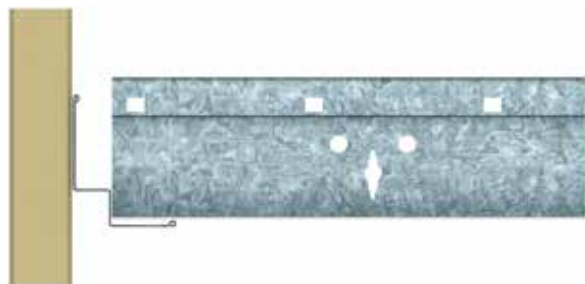
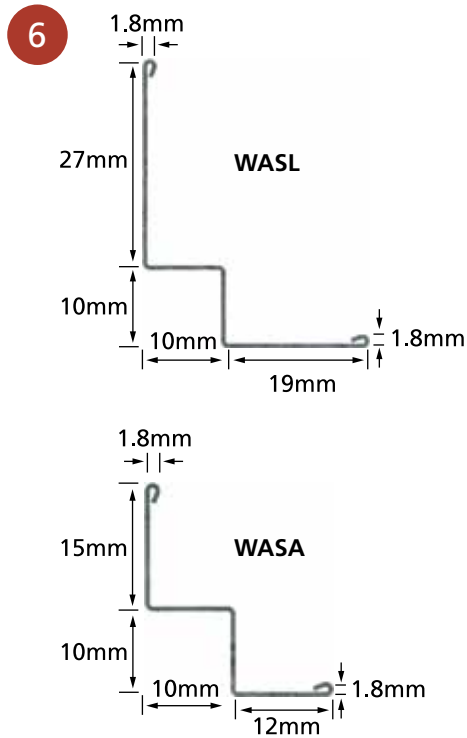

■ SHADOWLINE WALL ANGLES

■ SHADOWLINE TYPICAL APPLICATION

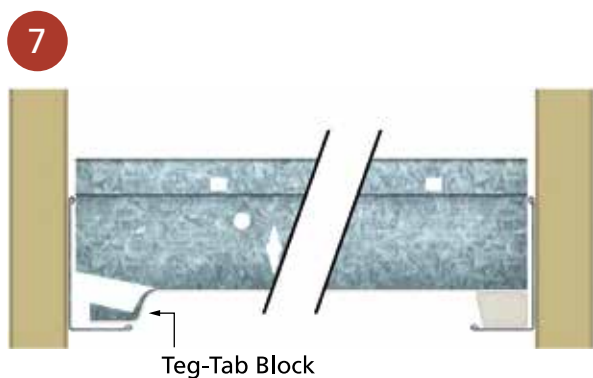

When setting out ceiling plane, lower Wall Angle accordingly to allow for these.

■ TEG-TAB BLOCKING

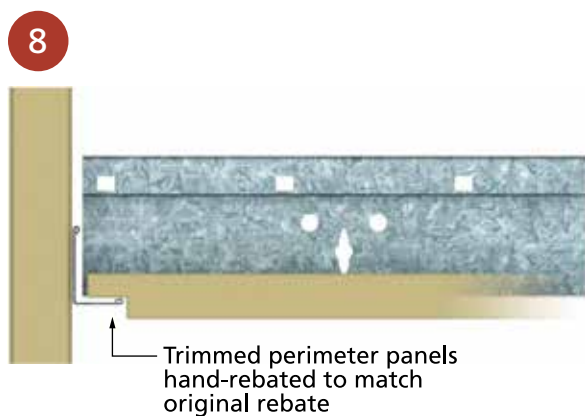

■ FIELD CUT OPTION

## Transition & Splice Clips

9

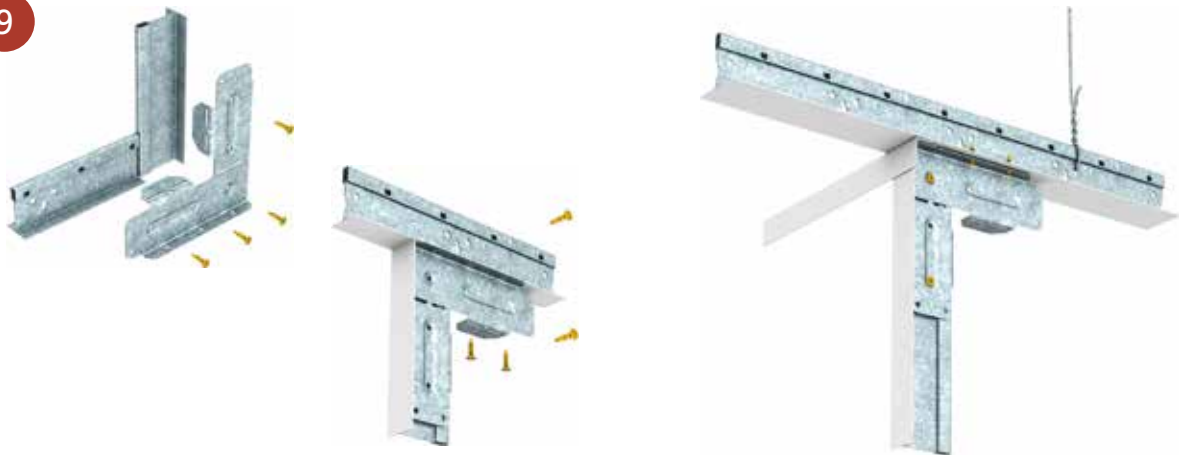

When installing the XD10 Transition Clip, bend the location tabs down over the head of the Tee. Secure the clip using self drilling screws as shown.

### NOTES:

1. The XD10 Transition Clip allows two grid members to be connected at 90°, regardless of face width.
2. Details are illustrative only. Additional suspension and/or strengthening of the ceiling grid may be required and specific details should be checked with Rondo.

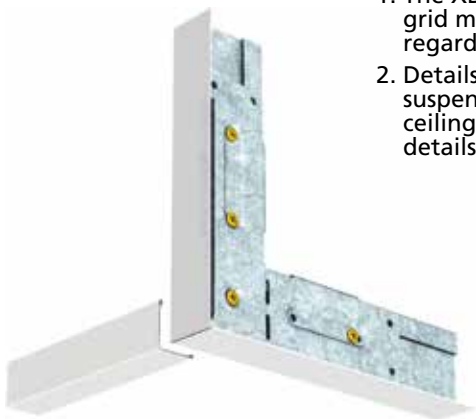

### ■ XD10 TRANSITION CLIP APPLICATIONS

10

**A** Primary Joiner for site cut Main Tees

**B** Off module Angle Joiner

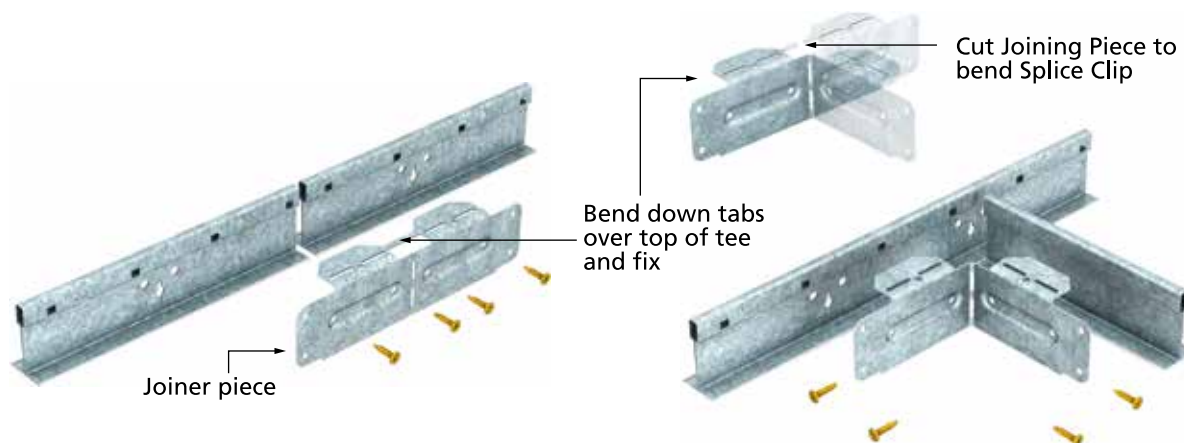

### ■ XDSC SPLICE CLIP APPLICATION

# TYPICAL APPLICATION DETAILS (continued)

## Joining & Retention Clips

11



XD19 Strongback Clip



XD36 3-Way Off-module Connector



XD35 Seismic Separation Joint Clip



XD20 Tee Face Sleeve

■ ALTERNATIVE JOINING METHODS

12

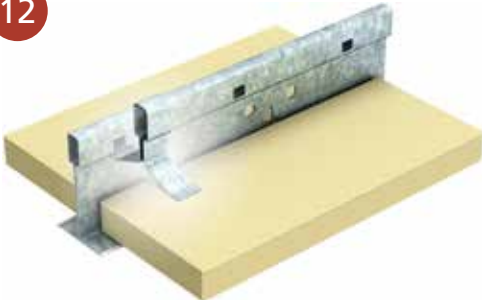

703 Tile Hold-down Clip



XD17 Seismic Clip, Grid to Wall Angle

■ RETENTION CLIPS

# INSTALLATION DETAILS

## Lighting Installation

The following guidelines are designed to assist in the correct specification and installation of light fittings in the Rondo DONN® Exposed Grid Ceiling System. The details shown are for light fittings weighing less than 7.5kg.

### LUMINAIRE POSITIONING

Typical recessed pan fitting arrangements are shown in Figure 13. Main Tees at 1200mm centres are shown horizontal, with suspension points (indicated by ●) at 1200mm centres.

Refer to the load tables on pages 22–25 for maximum allowable gross ceiling loads depending on type of luminaire and Rondo DONN® grid selected.

Where luminaire weight exceeds uniform load maximums consider:

- A higher specification Rondo DONN® Grid option if applicable (Refer to the load tables to ensure compliance).
- Independent support from structure.
- Additional suspension points as shown in Figure 14, or similar.

### ATTACHMENT OF LIGHT FITTINGS

#### LED/Fluorescent Recessed Pans/Troffer Packs

For fittings occupying a full ceiling module (e.g. 1200 x 600, 600 x 600, etc.) that are located on the bulb of the Tee or sit inside the Tee and rest on the flange.

With either method a positive fixing to the grid is recommended for safety reasons. This is required by the NZ Standard NZS 4219 (see page 13).

#### LED/Fluorescent Surface Fittings/Battens

Surface mounted luminaires are to be independently suspended from the structure such as to prevent them from falling more than 100mm. The tables on pages 22–25 are the total allowable loads, and surface mounted luminaires are additional to the weight of the ceiling tile.

#### Example:

Ceiling Grid Type A has a published value of 9.41kg/m<sup>2</sup>. Refer Page 22. Assuming the ceiling tile weighs 5kg/m<sup>2</sup>, then, for a 1200 x 600 luminaire, the maximum allowable weight is  $(9.41 - 5.0) \times 1.2 \times 0.6 = 3.1\text{kg}$

This is also less than the maximum of 7.5kg, therefore OK.

#### NOTE:

Any component installed within the ceiling grid that weighs 7.5kg or more shall be independently suspended from the structure.

13

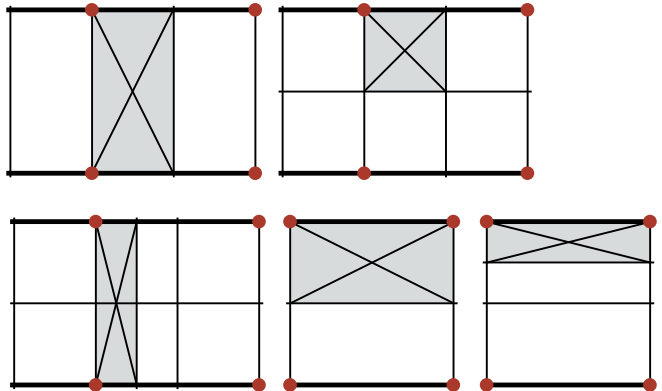

■ TYPICAL FITTING ARRANGEMENTS

14

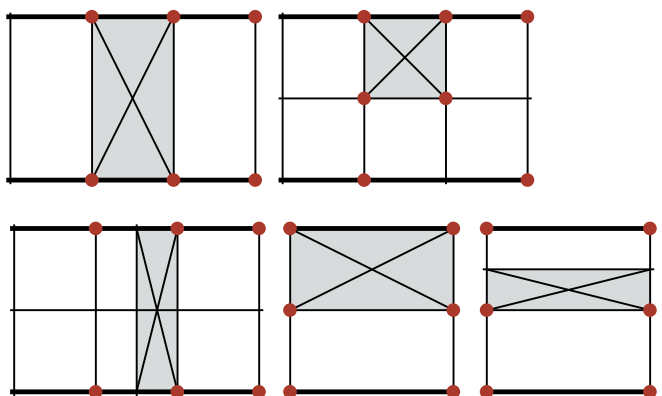

■ ADDITIONAL SUSPENSION POINTS

### HOW TO CHECK THE CEILING GRID FOR RECESSED LUMINAIRE WEIGHTS

- Take the allowable grid capacity from the tables on pages 22–25 and multiply it by the length and width of the luminaire.
- Check actual light weighs less than calculated value.

#### Example:

Ceiling Grid Type A has a published value of 9.41kg/m<sup>2</sup> (refer Page 22).

For a 1200 x 600 luminaire, the maximum allowable weight is:

$$9.41 \times 1.2 \times 0.6 = 6.7\text{kg}$$

This is also less than the maximum of 7.5kg, therefore OK.

# INSTALLATION DETAILS (continued)

## Lighting Installation: Construction Details

The details shown below are indicative of typical installation methods only. Under no circumstances is the luminaire to be supported on the ceiling tile only.

The specific installation detail is to be checked and confirmed, prior to installation based on the actual luminaire specified. Contact your nearest Rondo office for assistance.

### CEILING PANEL MOUNTED FITTINGS

Light fittings mounted through acoustical ceiling panels shall not rely on the ceiling panel for support.

Their weight shall be transferred back to the ceiling grid by one of the methods shown in Figure 15:

- a) Simple supports across the back of the panel
- b) Simple supports onto the top of the Tee bulb
- c) An additional rigid panel across the back of the ceiling panel (NB: This method will affect the acoustic properties of the ceiling panel)

15

**A**



END VIEW

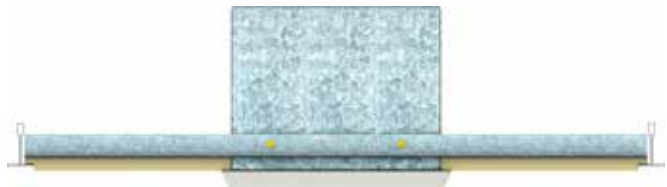

SIDE VIEW

**B**



END VIEW



SIDE VIEW

**C**



SIDE VIEW

■ CEILING PANEL LIGHT FITTING METHODS

### COMMON RECESSED LUMINAIRE OPTIONS

The table below is intended as a general guide only. Not all products are available in all areas. Local manufacturers may also provide compatible options. For full luminaire options, contact your nearest Lighting Company office.

COMPANY	TYPE	MODULE	GRID TYPE
GEC LIGHTING PHILIPS THORN LIGHTING	Troffer – Lay-in Diffuser	1200 x 600* 600 x 600 1200 x 300	Rondo DONN® 24mm Rondo DONN® 15mm
	Framed Diffuser	1200 x 600 600 x 600 1200 x 300	Rondo DONN® 24mm Rondo DONN® 15mm

*\*These options may be used with Rondo DONN® 15mm face grid when used in conjunction with a 3.5mm thick minimum prismatic diffuser.*

TIP: When specifying lighting, ensure the grid type is clearly identified in the lighting section (e.g. Rondo DONN® 15mm Exposed Grid or Rondo DONN® 24mm Exposed Grid).

### STANDARDS

The ceiling installation is to comply with the relevant Australian and New Zealand Standards current at the time of design or installation.

Much work has been done, and continues to be done in this area, which has resulted in some compatibility variances between the standards of compliance. The following provides some good practice recommendations.

#### Standards of compliance:

AS1170.4 Earthquake actions in Australia

AS/NZS2785 Suspended ceilings – Design and Installation

NZS1170.5 Earthquake actions – New Zealand

NZS4219 Seismic performance of engineering systems in buildings

Any equipment installed within the ceiling grid, weighing 7.5kg or more, shall be independently supported from the structure.

Independent supports of equipment shall not let the equipment drop more than 100mm.

Connections from ceiling supported equipment shall be made using flexible fittings only.

The ceiling and suspension systems shall be separated from the structure and/or services in accordance with NZS4219 Clause 5.2.1 Table 15, unless designed otherwise.

Fire sprinkler heads mounted in the ceiling shall be independently restrained and utilise a flexible connection.



# INSTALLATION DETAILS (continued)

## Requirements & Good Design Practices

*Suspended ceilings are finished products intended for interior use and should be treated accordingly.*

### MAIN TEE

- For standard installations, Main Tees are spaced at 1200mm centres.
- Where heavy ceiling panels are used, close Main Tee spacing to 600mm centres. Refer to the load tables on page 22–25.
- Main Tee integral splices are to be offset from each other across the ceiling. Where this cannot be avoided, aligned splices shall be mechanically fastened with a pop-rivet, Tek® Screw or using the XDSC Clip.

### CROSS TEE

- Cross Tees interlock with opposing Cross Tees through the Main Tee web slots to form the required module.
- A positive “click” is heard when the Rondo DONN® QRC tab correctly engages (Figure 16).
- The Cross Tee being installed should be inserted on the **left side** of the **already installed** Cross Tee.
- Slots are punched along the Main Tee for convenience at 100mm centres for metric systems.
- Main and Cross Tees can be arranged in a variety of module configurations. (See load tables on pages 22–25 for standard common layouts.)

16

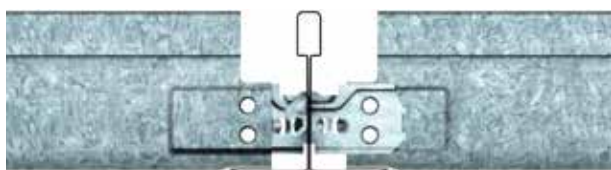

■ QRC TAB

### SUSPENSION

- Main Tee hangers are spaced at 1200mm centres, no more than 600mm from the perimeter Wall Trim or 150mm from the Main Tee splice or 200mm from the Main Tee/Cross Tee joint. For heavier ceilings closer spacings may be required and/or hangers provided through the Cross Tee. Ceiling tile weight and suspension setout must be in accordance with the values in the load tables on pages 22–25.

Where the ceiling grid is not rigidly fixed to the perimeter wall or is back braced:

- Provide a hanger within 200mm of the perimeter wall to each Main and Cross Tee or;
- Install an XD17 Seismic Clip to each Main and Cross Tee.

#### Suspension methods include:

- 2.5mm diameter straightened galvanised wire located through the pre-punched convenience holes in the Main Tee bulb or web and secured with three tight 360° turns (refer Figure 17A).
- 2.5mm wire or 5mm Rondo galvanised rod with the DXCL suspension clip over the bulb (refer Figure 17B).
- 5mm Rondo rod with the 719 clip through pre-punched hole in the web or bulb (refer Figure 17C). For New Zealand Seismic design please contact your local Rondo Technical Representative.
- Rondo DONN® Direct Fixing Clips **between bulb holes only** (no closer than 10mm to the bulb holes) (refer Figure 17D).
- A system of flat steel strip or Wall Angle secured to the tee web with fasteners. The system shall be fully compliant with AS/NZS 2785, Section 3 (refer Figure 17E).
- Hangers are not to be bent or kinked as a means of levelling the grid or for any other reason.
- Hangers or bracing are not to be fixed to, or closer than 150mm to plenum building services e.g. ducting, sprinkler pipes.
- Fixing of the hanger to the structure above shall be in accordance with their manufacturers recommendations, be suitable for the structure material and comply with any required Standards. Such fasteners shall be fully compliant with AS/NZS 2785, Section 3.
- Hangers using the DXCL clip shall not vary from the vertical by more than 5°.
- Where hangers are splayed up to a maximum of 20° (1H:2.74V) to the vertical, they should always have an equally applied hanger in the opposite direction.

#### NOTE

Suspension method and position may be dependant on load requirements (see load tables on pages 22–25).

17

**A**



Rondo 120 soft galvanised wire secured with three tight 360° turns

**B**



Suspension Clip Part No DXCL

**C**



Suspension Clip Part No 719  
*(For New Zealand Seismic design please contact your local Rondo Technical Representative)*

**D**

DXDF no closer than 10mm to bulb hole

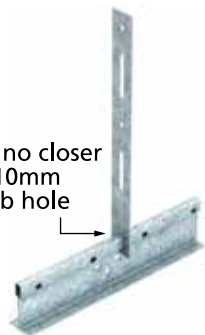

Direct Fix Strap Part No DXDF

**E**

2/#10 wafer head screws, installed from Tee Bar side



WAH/SA12 secured to tee web

■ SUSPENSION METHODS

18

Two wires are required to balance the ceiling. One will not work

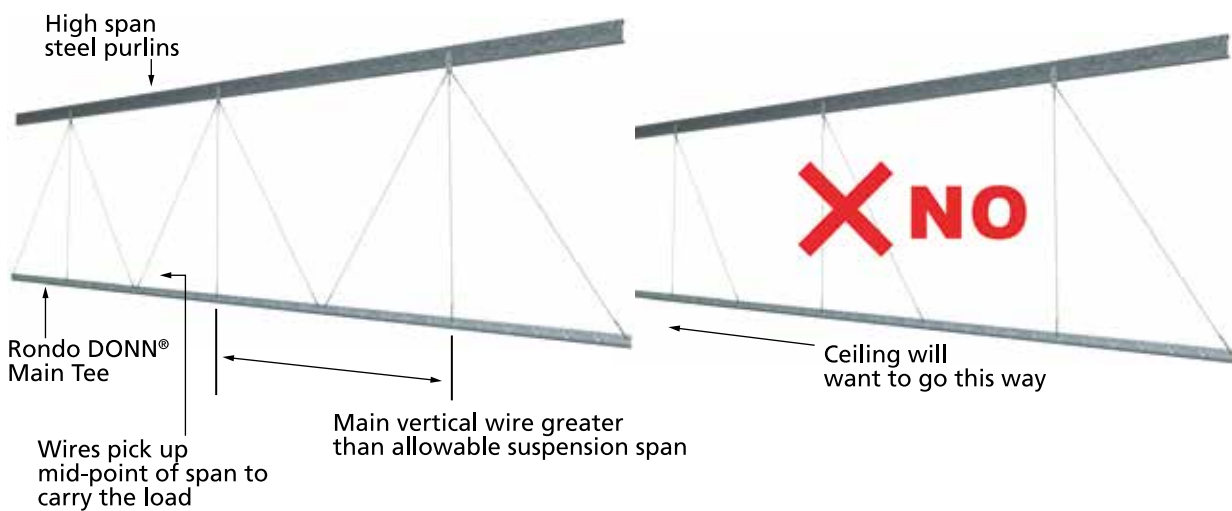

■ CORRECT USE OF WIRES

## INSTALLATION DETAILS (continued)

### Requirements & Good Design Practices (continued)

#### WALL PERIMETER

A variety of different Wall Angle profiles are available to suit the Rondo DONN® Brand systems and designer's requirements. See *Wall Angles* on page 7 for details.

Typically, fix trim to walls or bulkheads at not more than 600mm centres maximum.

#### PANEL HOLD DOWN CLIPS

Clips may be required for seismic restraint, fire ratings or wind uplift on ceiling panels.

- Typically, install 2 Hold Down Clips (703) per parallel tee (Cross or Main). This will give four points per panel restraint.
- Where frequent access in to the plenum is anticipated, some clips can have one side removed to allow clipping one side of the tee but access on the other.
- Ensure clips are of a type suitable for Rondo DONN® 15mm or 24mm and for the thickness of acoustical panel being clipped.
- The 703 can be used for ceiling tiles up to 16mm thick maximum.

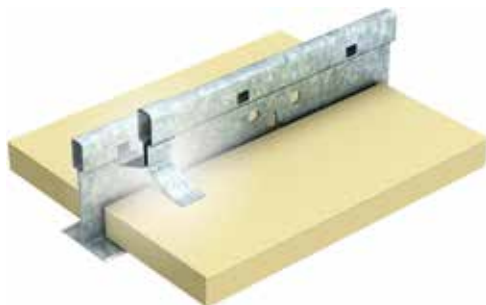

■ 703 TILE HOLD-DOWN CLIP

#### PLENUM DEPTHS

Minimum plenum depths for the ease of removal:

- 600 x 600mm panels = 150mm
- 1200 x 600mm panels = 200mm

Where lesser plenum depth is required, particularly under non-continuous structure or services like joists/purlins or ducts, side loading of ceiling panels can further reduce the depth in these areas to 88mm (subject to panel thickness). At no time should the vertical clearance, between the head of the Tee Bar and the service, be less than 50mm as per NZS4219.

#### CUTTING

Grid and Wall Angle systems are easily cut on site with metal snips or fine-toothed band or hack saws.

#### LIGHTING/AIR HANDLING

Most standard luminaires, louvres, grills and linear diffusers integrate with the standard module configurations. Refer to Lighting Installation on pages 11 and 12 for specific details.

#### THERMAL PROPERTIES

The Rondo DONN® ceiling grid is manufactured from coated steel complying with AS1397. Steel can expand or contract subject to thermal movement, in the order of 0.13mm per metre length of grid for every 10°C change in temperature. This should be considered in the design.

#### HEALTH & SAFETY

The material composition represents no health hazard. When handling, take care and ensure that safe work practices are adhered to at all times. Some products may have surface treatments and sharp edges/ends. All reasonable care should be taken when handling or installing to avoid any potential injury to self or others.

Users should be properly trained and supervised in the use and handling of these materials. Appropriate personal protective equipment should be used when necessary (e.g. gloves/glasses etc.) to avoid any potential injuries.

## MAINTENANCE

### CLEANING

- Remove ceiling panels, then perform necessary cleaning of the grid with non-solvent based proprietary cleaner.

### PAINTING

- Repainting of grid system members should be with a high quality solvent based paint for use over metal surfaces and applied as recommended by the paint manufacturer.

### PAINT COLOUR

- Powder coating: PPG Industries - Product Code PE522 polyester matt  
Colour Code 9249AN ANOGRain Pacific White
- Wet spray: PPG Industries - Product Code 262 Speedlac (nitro-cellulose lacquer)  
Colour Code 34063 Pacific White NZ

## MATERIALS

Main and Cross Tees are a double web design, roll formed from hot dipped galvanised steel with prepainted galvanised steel cap.

Cross Tees have a Rondo DONN® QRC high tensile steel tab clinched to each end, zinc chromate finish.

## PARTITIONS

A partitions mass may impact on the installation requirements of a suspended ceiling due to seismic movement. Partitions are not to be rigidly fixed to the suspended ceiling, rather they should be independently braced to the structure for seismic or other imposed loading.

*Refer to Rondo for specific seismic installation advice.*

# TRANSITION TO THE RONDO XPRESS® DRYWALL GRID SYSTEM

The Rondo DONN® Exposed Grid Ceiling System is compatible with the Rondo XPRESS® Drywall Grid Ceiling System, making it easy to transition between concealed and exposed ceilings.

Both flush and offset transitions are possible, and additional Cross Tees are necessary at plasterboard edges to provide adequate support.

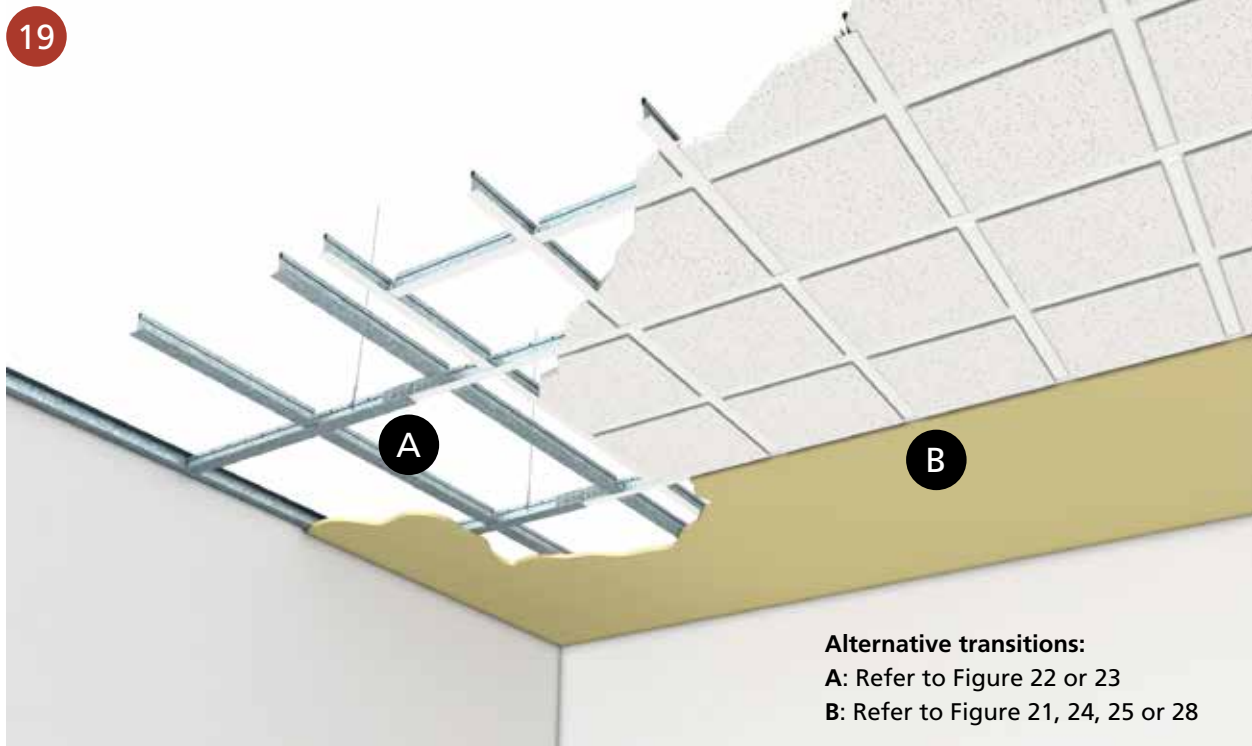

**Alternative transitions:**  
**A:** Refer to Figure 22 or 23  
**B:** Refer to Figure 21, 24, 25 or 28

■ TYPICAL RONDO DONN® AND RONDO XPRESS® DRYWALL TRANSITION

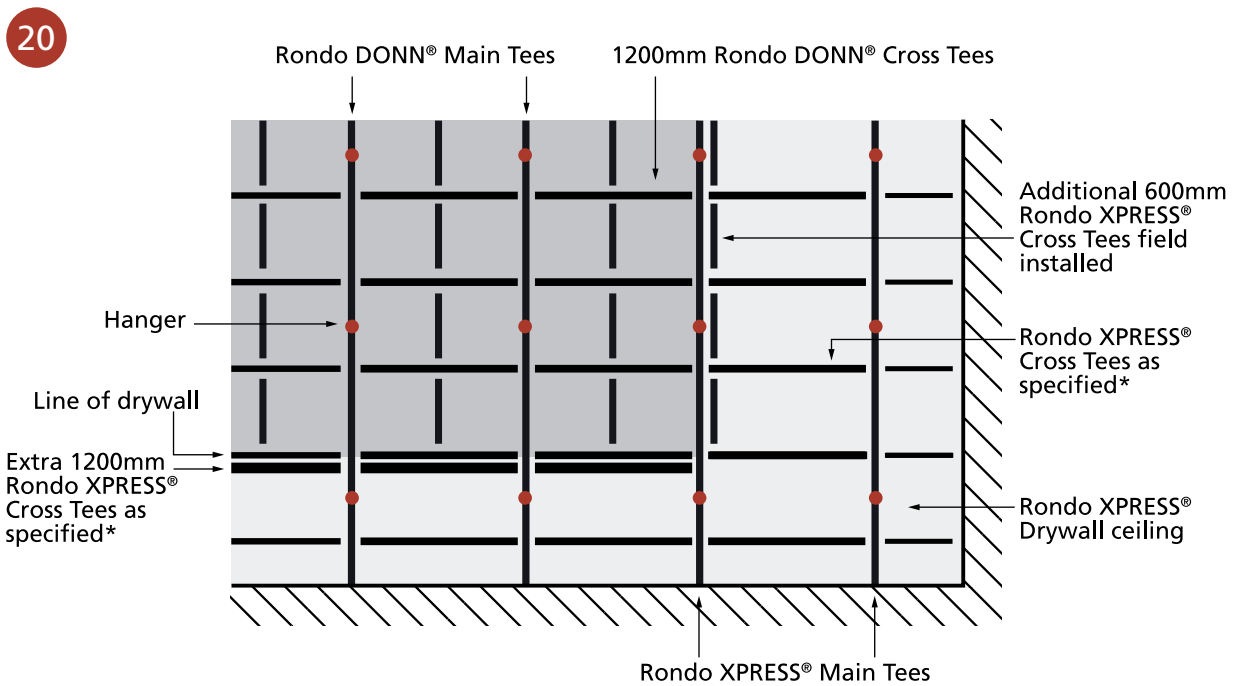

\*Drywall board manufacturer's requirements

■ TYPICAL PLAN VIEW OF RONDO DONN® AND RONDO XPRESS® DRYWALL TRANSITION

# RONDO DONN® TO RONDO XPRESS®

## Typical Application

21

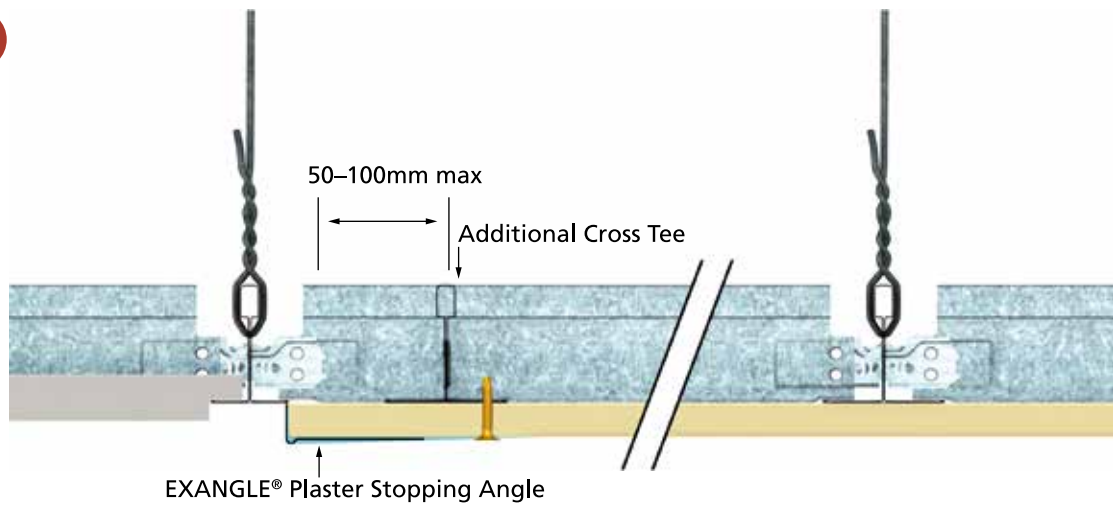

■ RONDO DONN® EXPOSED GRID TRANSITION TO RONDO XPRESS® DRYWALL GRID

22

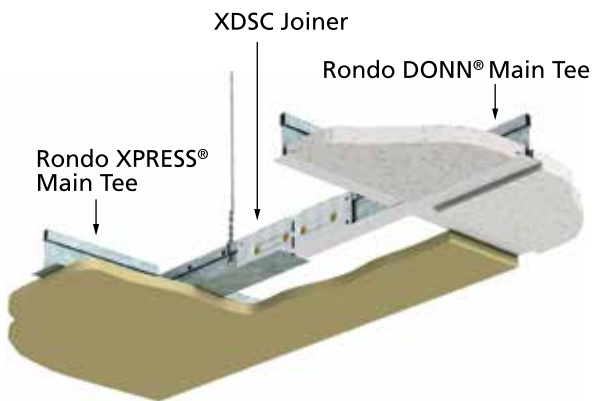

■ DRYWALL TO EXPOSED GRID TRANSITION: SITE CUT CONNECTION

23

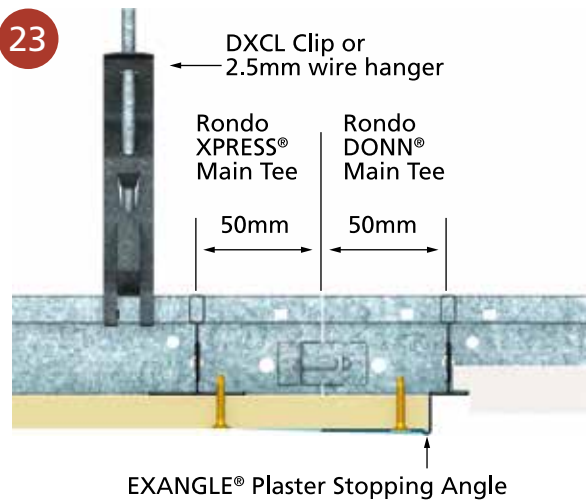

■ DRYWALL TO EXPOSED GRID TRANSITION: FACTORY END CONNECTION

24

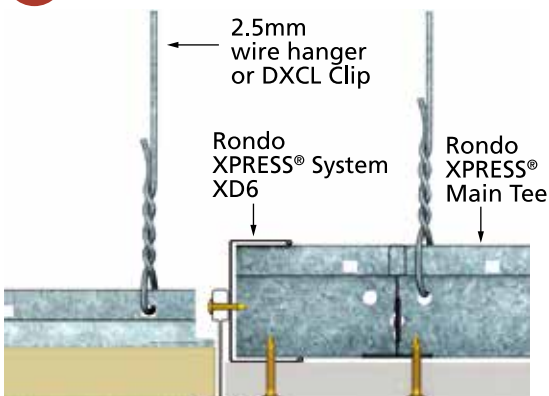

■ FLUSH TRANSITION

25

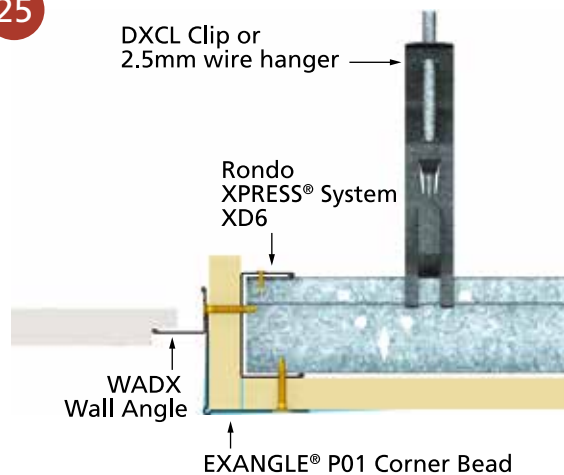

■ STANDARD OFFSET TRANSITION



# RONDO DONN® TO RONDO XPRESS® (continued)

## Transition Clip

The Transition Clip provides seamless transitions between concealed and exposed grid ceilings, offering designers greater flexibility.

Where a flush transition is desired, the Rondo XD11 Clip can be used to accept Rondo XPRESS® Grid as shown below.

NOTE: The use of the XD11 Acoustical Transition Clip is not suitable for New Zealand Seismic Conditions.

26



■ XD11 ACOUSTICAL TRANSITION CLIP

27

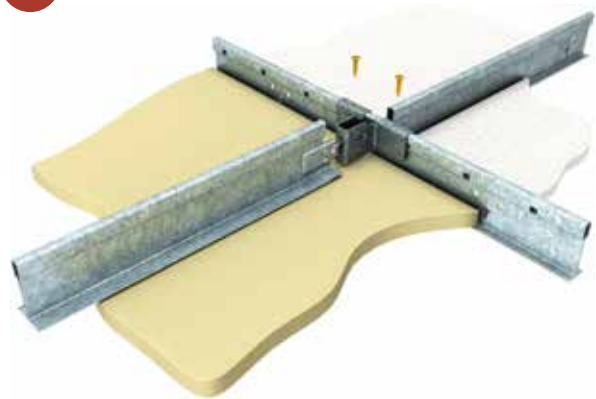

■ XD11 ACOUSTICAL TRANSITION CLIP APPLICATION

28



■ RONDO XPRESS DRYWALL XD11 TRANSITION CLIP INTERSECTION DETAILS



For Main Tee direction, keep the Rondo DONN® Exposed Grid Main Tees and the Rondo XPRESS® Drywall Main Tees in line.  
 Three options are shown below.

29

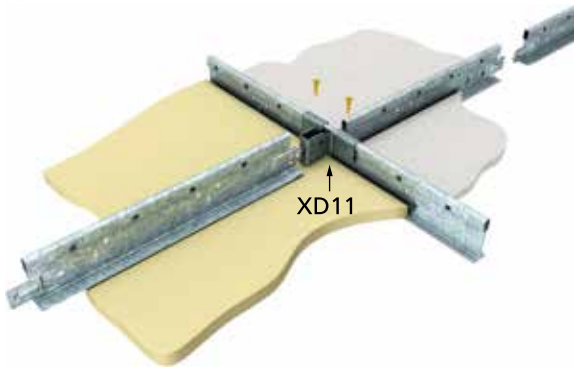

■ OPTION 1: XD11 TRANSITION CLIP

30

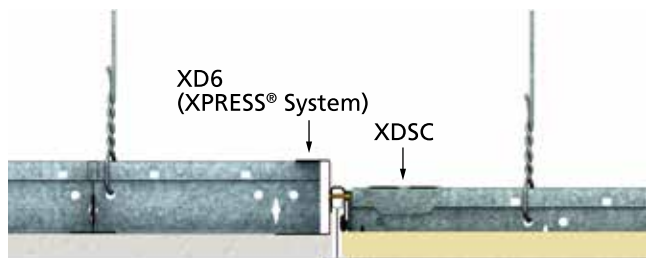
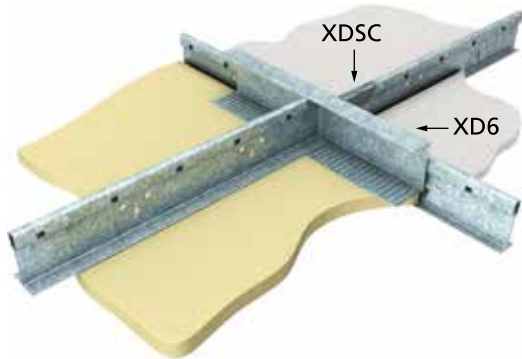

■ OPTION 2: XDSC SPLICE CLIP & XD6 WALL CHANNEL

31

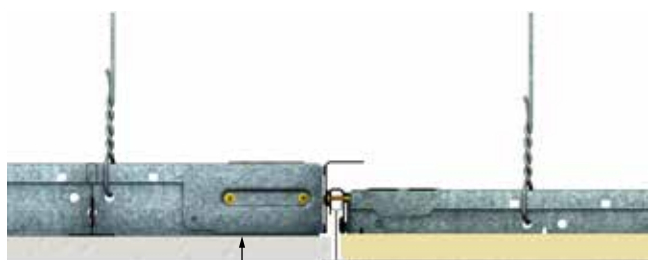
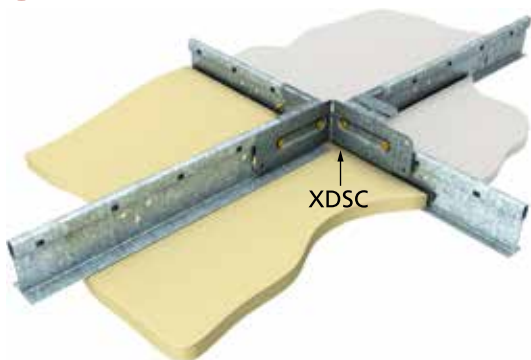

■ OPTION 3: XDSC SPLICE CLIP

# RONDO DONN® 24mm GRID CONFIGURATIONS & LOAD TABLES

**A**

Check the allowable ceiling grid load using the column with the preferred suspension system shown.

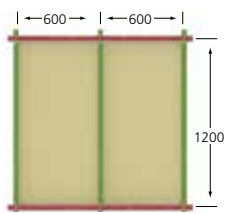

USING A BULB HOLE	USING A WEB HOLE	USING A BULB HOLE	USING A WEB HOLE	USING A DXCL CLIP	USING A DXDF STRAP
Ø 2.5 wire	Ø 2.5 wire	719 Hook	719 Hook		(no closer than 10mm to the bulb holes)

Main Tee Span (mm) is: Between Hanger Points

Main Tee	Cross Tee	Cross Tee	1000	1100	1200	1000	1100	1200	1000	1100	1200	1000	1100	1200	1000	1100	1200	1000	1100	1200
<b>Allowable Load (kg/m<sup>2</sup>)</b>																				
DX1H	DX2H	—	25.0	22.4	20.2	31.5	31.5	25.5	18.9	16.9	15.1	24.1	21.6	19.5	31.5	31.5	25.5	31.5	31.5	25.5
	DX2	—	21.0	21.0	20.2	21.0	21.0	21.0	18.9	16.9	15.1	21.0	21.0	19.5	21.0	21.0	21.0	21.0	21.0	21.0
	DX3	—	14.5	14.5	14.5	14.5	14.5	14.5	14.5	14.5	14.5	14.5	14.5	14.5	14.5	14.5	14.5	14.5	14.5	14.5
DX1	DX2H	—	19.9	17.7	15.9	30.0	24.0	19.5	18.9	16.9	15.1	24.1	21.6	19.5	30.0	24.0	19.5	27.9	24.0	19.5
	DX2	—	19.9	17.7	15.9	21.0	21.0	19.5	18.9	16.9	15.1	21.0	21.0	19.5	21.0	21.0	19.5	21.0	21.0	19.5
	DX3	—	14.5	14.5	14.5	14.5	14.5	14.5	14.5	14.5	14.5	14.5	14.5	14.5	14.5	14.5	14.5	14.5	14.5	14.5

**B**

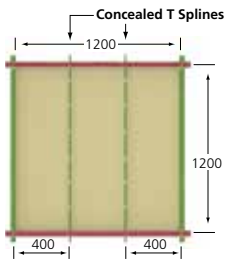

Main Tee	Cross Tee	Cross Tee	1000	1100	1200	1000	1100	1200	1000	1100	1200	1000	1100	1200	1000	1100	1200	1000	1100	1200
<b>Allowable Load (kg/m<sup>2</sup>)</b>																				
DX1H	DX2H	—	25.0	22.4	20.2	40.0	32.5	26.5	18.9	16.9	15.1	24.1	21.6	19.5	40.0	32.5	26.5	40.0	32.5	26.5
	DX2	—	25.0	22.4	20.2	33.5	32.5	26.5	18.9	16.9	15.1	24.1	21.6	19.5	33.5	32.5	26.5	33.5	32.5	26.5
	DX3	—	24.0	22.4	20.2	24.0	24.0	24.0	18.9	16.9	15.1	24.0	21.6	19.5	24.0	24.0	24.0	24.0	24.0	24.0
DX1	DX2H	—	19.9	17.7	15.9	31.0	24.5	20.0	18.9	16.9	15.1	24.1	21.6	19.5	31.0	24.5	20.0	27.9	24.5	20.0
	DX2	—	19.9	17.7	15.9	31.0	24.5	20.0	18.9	16.9	15.1	24.1	21.6	19.5	31.0	24.5	20.0	27.9	24.5	20.0
	DX3	—	19.9	17.7	15.9	24.0	24.0	20.0	18.9	16.9	15.1	24.0	21.6	19.5	24.0	24.0	20.0	24.0	24.0	20.0

**C**

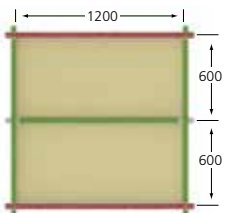

Main Tee	Cross Tee	Cross Tee	1000	1100	1200	1000	1100	1200	1000	1100	1200	1000	1100	1200	1000	1100	1200	1000	1100	1200
<b>Allowable Load (kg/m<sup>2</sup>)</b>																				
DX1H	DX2H	—	13.0	13.0	13.0	13.0	13.0	13.0	13.0	13.0	13.0	13.0	13.0	13.0	13.0	13.0	13.0	13.0	13.0	13.0
	DX2	—	10.0	10.0	10.0	10.0	10.0	10.0	10.0	10.0	10.0	10.0	10.0	10.0	10.0	10.0	10.0	10.0	10.0	10.0
	DX3	—	5.50	5.50	5.50	5.50	5.50	5.50	5.50	5.50	5.50	5.50	5.50	5.50	5.50	5.50	5.50	5.50	5.50	5.50
DX1	DX2H	—	13.0	13.0	13.0	13.0	13.0	13.0	13.0	13.0	13.0	13.0	13.0	13.0	13.0	13.0	13.0	13.0	13.0	13.0
	DX2	—	10.0	10.0	10.0	10.0	10.0	10.0	10.0	10.0	10.0	10.0	10.0	10.0	10.0	10.0	10.0	10.0	10.0	10.0
	DX3	—	5.50	5.50	5.50	5.50	5.50	5.50	5.50	5.50	5.50	5.50	5.50	5.50	5.50	5.50	5.50	5.50	5.50	5.50

**D**

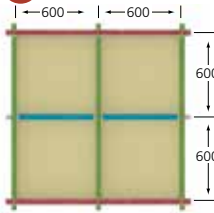

Check the allowable ceiling grid load using the column with the preferred suspension system shown.

USING A BULB HOLE	USING A WEB HOLE	USING A BULB HOLE	USING A WEB HOLE	USING A DXCL CLIP	USING A DXDF STRAP
Ø 2.5 wire	Ø 2.5 wire	719 Hook	719 Hook		(no closer than 10mm to the bulb holes)

Main Tee Span (mm) ie: Between Hanger Points

Main Tee	Cross Tee	Cross Tee	1000	1100	1200	1000	1100	1200	1000	1100	1200	1000	1100	1200	1000	1100	1200	1000	1100	1200
<b>Allowable Load (kg/m<sup>2</sup>)</b>																				
DX1H	DX2H	DX4	25.0	22.4	20.2	31.0	31.0	25.0	18.9	16.9	15.1	24.1	21.6	19.5	31.0	31.0	25.0	31.0	31.0	25.0
	DX2	DX4	24.5	22.4	20.2	24.5	24.5	24.5	18.9	16.9	15.1	24.1	21.6	19.5	24.5	24.5	24.5	24.5	24.5	24.5
	DX3	DX4	15.0	15.0	15.0	15.0	15.0	15.0	15.0	15.0	15.0	15.0	15.0	15.0	15.0	15.0	15.0	15.0	15.0	15.0
DX1	DX2H	DX4	19.9	17.7	15.9	29.5	23.5	19.0	18.9	16.9	15.1	24.1	21.6	19.0	29.5	23.5	19.0	27.9	23.5	19.0
	DX2	DX4	19.9	17.7	15.9	24.5	23.5	19.0	18.9	16.9	15.1	24.1	21.6	19.0	24.5	23.5	19.0	24.5	23.5	19.0
	DX3	DX4	15.0	15.0	15.0	15.0	15.0	15.0	15.0	15.0	15.0	15.0	15.0	15.0	15.0	15.0	15.0	15.0	15.0	15.0

**E**

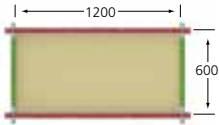

Main Tee	Cross Tee	Cross Tee	1000	1100	1200	1000	1100	1200	1000	1100	1200	1000	1100	1200	1000	1100	1200	1000	1100	1200
<b>Allowable Load (kg/m<sup>2</sup>)</b>																				
DX1H	DX2H	—	50.0	44.8	40.4	64.5	52.5	43.5	37.8	33.8	30.2	48.2	43.2	39.0	64.5	52.5	43.5	64.5	52.5	43.5
	DX2	—	50.0	44.8	40.4	64.5	52.5	43.5	37.8	33.8	30.2	48.2	43.2	39.0	64.5	52.5	43.5	64.5	52.5	43.5
	DX3	—	49.5	44.8	40.4	49.5	49.5	43.5	37.8	33.8	30.2	48.2	43.2	39.0	49.5	49.5	43.5	49.5	49.5	43.5
	DX4	—	38.5	38.5	38.5	38.5	38.5	38.5	37.8	33.8	30.2	38.5	38.5	38.5	38.5	38.5	38.5	38.5	38.5	38.5
DX1	DX2H	—	39.8	35.4	31.8	49.0	39.5	32.5	37.8	33.8	30.2	48.2	39.5	32.5	49.0	39.5	32.5	49.0	39.5	32.5
	DX2	—	39.8	35.4	31.8	49.0	40.0	32.5	37.8	33.8	30.2	48.2	40.0	32.5	49.0	40.0	32.5	49.0	40.0	32.5
	DX3	—	39.8	35.4	31.8	49.0	40.0	32.5	37.8	33.8	30.2	48.2	40.0	32.5	49.0	40.0	32.5	49.0	40.0	32.5
	DX4	—	38.5	35.4	31.8	38.5	38.5	32.5	37.8	33.8	30.2	38.5	38.5	32.5	38.5	38.5	32.5	38.5	38.5	32.5

**F**

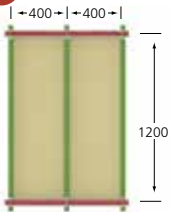

Main Tee	Cross Tee	Cross Tee	1000	1100	1200	1000	1100	1200	1000	1100	1200	1000	1100	1200	1000	1100	1200	1000	1100	1200
<b>Allowable Load (kg/m<sup>2</sup>)</b>																				
DX1H	DX2H	—	25.0	22.4	20.2	40.0	32.5	26.5	18.9	16.9	15.1	24.1	21.6	19.5	40.0	32.5	26.5	40.0	32.5	26.5
	DX2	—	25.0	22.4	20.2	33.5	32.5	26.5	18.9	16.9	15.1	24.1	21.6	19.5	33.5	32.5	26.5	33.5	32.5	26.5
	DX3	—	24.0	22.4	20.2	24.0	24.0	24.0	18.9	16.9	15.1	24.0	21.6	19.5	24.0	24.0	24.0	24.0	24.0	24.0
DX1	DX2H	—	19.9	17.7	15.9	31.1	25.7	20.9	18.9	16.9	15.1	24.1	21.6	19.5	31.5	25.7	20.9	27.9	25.0	20.9
	DX2	—	19.9	17.7	15.9	31.1	25.7	20.9	18.9	16.9	15.1	24.1	21.6	19.5	31.5	25.7	20.9	27.9	25.0	20.9
	DX3	—	19.9	17.7	15.9	21.7	21.7	20.9	18.9	16.9	15.1	21.7	21.6	19.5	21.7	21.7	20.9	21.7	21.7	20.9

# RONDO DONN® 24mm GRID CONFIGURATIONS & LOAD TABLES

Check the allowable ceiling grid load using the column with the preferred suspension system shown.

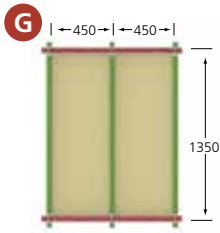

USING A BULB HOLE	USING A WEB HOLE	USING A BULB HOLE	USING A WEB HOLE	USING A DXCL CLIP	USING A DXDF STRAP
Ø 2.5 wire	Ø 2.5 wire	719 Hook	719 Hook		(no closer than 10mm to the bulb holes)

Main Tee Span (mm) ie: Between Hanger Points

Main Tee	Cross Tee	Cross Tee	1000	1100	1200	1000	1100	1200	1000	1100	1200	1000	1100	1200	1000	1100	1200	1000	1100	1200
Allowable Load (kg/m <sup>2</sup> )																				
DX1H	DX2H	—	25.0	22.4	20.2	29.0	28.0	23.0	18.9	16.9	15.1	24.1	21.6	19.5	29.0	28.0	23.0	29.0	28.0	23.0
	DX2	—	19.5	19.5	19.5	19.5	19.5	19.5	18.9	16.9	15.1	19.5	19.5	19.5	19.5	19.5	19.5	19.5	19.5	19.5
	DX3	—	13.5	13.5	13.5	13.5	13.5	13.5	13.5	13.5	13.5	13.5	13.5	13.5	13.5	13.5	13.5	13.5	13.5	13.5
DX1	DX2H	—	19.9	17.7	15.9	27.0	21.5	17.0	18.9	16.9	15.1	24.1	21.5	17.0	27.0	21.5	17.0	27.0	21.5	17.0
	DX2	—	19.5	17.7	15.9	19.5	19.5	17.0	18.9	16.9	15.1	19.5	19.5	17.0	19.5	19.5	17.0	19.5	19.5	17.0
	DX3	—	13.5	13.5	13.5	13.5	13.5	13.5	13.5	13.5	13.5	13.5	13.5	13.5	13.5	13.5	13.5	13.5	13.5	13.5

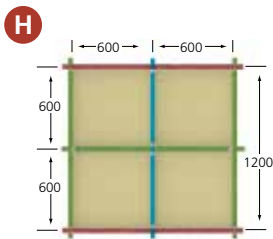

Main Tee	Cross Tee	Cross Tee	1000	1100	1200	1000	1100	1200	1000	1100	1200	1000	1100	1200	1000	1100	1200	1000	1100	1200
Allowable Load (kg/m <sup>2</sup> )																				
DX1H	DX2H	DX4	13.0	13.0	13.0	13.0	13.0	13.0	13.0	13.0	13.0	13.0	13.0	13.0	13.0	13.0	13.0	13.0	13.0	13.0
	DX2	DX4	9.80	9.80	9.80	9.80	9.80	9.80	9.80	9.80	9.80	9.80	9.80	9.80	9.80	9.80	9.80	9.80	9.80	9.80
	DX3	DX4	5.20	5.20	5.20	5.20	5.20	5.20	5.20	5.20	5.20	5.20	5.20	5.20	5.20	5.20	5.20	5.20	5.20	5.20
DX1	DX2H	DX4	13.0	13.0	13.0	13.0	13.0	13.0	13.0	13.0	13.0	13.0	13.0	13.0	13.0	13.0	13.0	13.0	13.0	13.0
	DX2	DX4	9.90	9.90	9.90	9.90	9.90	9.90	9.90	9.90	9.90	9.90	9.90	9.90	9.90	9.90	9.90	9.90	9.90	9.90
	DX3	DX4	5.30	5.30	5.30	5.30	5.30	5.30	5.30	5.30	5.30	5.30	5.30	5.30	5.30	5.30	5.30	5.30	5.30	5.30

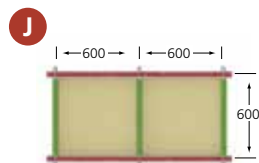

Main Tee	Cross Tee	Cross Tee	1000	1100	1200	1000	1100	1200	1000	1100	1200	1000	1100	1200	1000	1100	1200	1000	1100	1200
Allowable Load (kg/m <sup>2</sup> )																				
DX1H	DX2H	—	50.0	44.8	40.4	82.5	67.5	56.0	37.8	33.8	30.2	48.2	43.2	39.0	82.5	67.5	56.0	82.5	67.5	56.0
	DX2	—	50.0	44.8	40.4	83.0	67.5	56.0	37.8	33.8	30.2	48.2	43.2	39.0	83.0	67.5	56.0	83.0	67.5	56.0
	DX3	—	50.0	44.8	40.4	83.0	67.5	56.0	37.8	33.8	30.2	48.2	43.2	39.0	83.0	67.5	56.0	83.0	67.5	56.0
DX1	DX2H	—	39.8	35.4	31.8	62.2	52.5	43.5	33.0	29.4	26.2	47.2	42.2	38.0	63.0	52.5	43.5	55.8	50.0	43.5
	DX2	—	39.8	35.4	31.8	62.2	52.5	43.5	33.0	29.4	26.2	47.2	42.2	38.0	63.0	52.5	43.5	55.8	50.0	43.5
	DX3	—	39.8	35.4	31.8	62.2	52.5	43.5	33.0	29.4	26.2	47.2	42.2	38.0	63.0	52.5	43.5	55.8	50.0	43.5

# RONDO DONN® 15mm GRID CONFIGURATIONS & LOAD TABLES

Check the allowable ceiling grid load using the column with the preferred suspension system shown.

USING A BULB HOLE	USING A WEB HOLE	USING A DXCL CLIP	USING A DXDF STRAP
 Ø 2.5 wire or 719 Hook	 Ø 2.5 wire or 719 Hook		 (no closer than 10mm to the bulb holes)

Main Tee Span (mm) ie: Between Hanger Points

	Main Tee	Cross Tee	Cross Tee	1000	1100	1200	1000	1100	1200	1000	1100	1200	1000	1100	1200
				Allowable Load (kg/m <sup>2</sup> )											
				DC1H	DC2H	—	4.85	4.85	4.85	4.85	4.85	4.85	4.85	4.85	4.85
DC1H	DC2S	—	3.48	3.48	3.48	3.48	3.48	3.48	3.48	3.48	3.48	3.48	3.48	3.48	3.48
DC1S	DC2H	—	4.85	4.85	4.85	4.85	4.85	4.85	4.85	4.85	4.85	4.85	4.85	4.85	4.85
DC1S	DC2S	—	3.48	3.48	3.48	3.48	3.48	3.48	3.48	3.48	3.48	3.48	3.48	3.48	3.48

	Main Tee	Cross Tee	Cross Tee	1000	1100	1200	1000	1100	1200	1000	1100	1200	1000	1100	1200
				Allowable Load (kg/m <sup>2</sup> )											
				DC1H	DC2H	—	9.63	9.63	9.63	9.63	9.63	9.63	9.63	9.63	9.63
DC1H	DC2S	—	7.57	7.57	7.57	7.57	7.57	7.57	7.57	7.57	7.57	7.57	7.57	7.57	7.57
DC1S	DC2H	—	9.63	9.63	9.63	9.63	9.63	9.63	9.63	9.63	9.63	9.63	9.63	9.63	9.63
DC1S	DC2S	—	7.57	7.57	7.57	7.57	7.57	7.57	7.57	7.57	7.57	7.57	7.57	7.57	7.57

	Main Tee	Cross Tee	Cross Tee	1000	1100	1200	1000	1100	1200	1000	1100	1200	1000	1100	1200
				Allowable Load (kg/m <sup>2</sup> )											
				DC1H	DC2H	DC2H	4.85	4.85	4.85	4.85	4.85	4.85	4.85	4.85	4.85
DC1H	DC2S	DC2S	3.48	3.48	3.48	3.48	3.48	3.48	3.48	3.48	3.48	3.48	3.48	3.48	3.48
DC1S	DC2H	DC2H	4.85	4.85	4.85	4.85	4.85	4.85	4.85	4.85	4.85	4.85	4.85	4.85	4.85
DC1S	DC2S	DC2S	3.48	3.48	3.48	3.48	3.48	3.48	3.48	3.48	3.48	3.48	3.48	3.48	3.48

	Main Tee	Cross Tee	Cross Tee	1000	1100	1200	1000	1100	1200	1000	1100	1200	1000	1100	1200
				Allowable Load (kg/m <sup>2</sup> )											
				DC1H	DC2H	DC2S	18.3	18.3	18.3	18.3	18.3	18.3	18.3	18.3	18.3
DC1H	DC2S	DC2S	14.4	14.4	14.4	14.4	14.4	14.4	14.4	14.4	14.4	14.4	14.4	14.4	14.4
DC1S	DC2H	DC2S	17.2	15.3	13.7	18.3	18.3	15.3	18.3	18.3	15.3	18.3	17.1	15.3	15.3
DC1S	DC2S	DC2S	14.4	14.4	13.7	14.4	14.4	14.4	14.4	14.4	14.4	14.4	14.4	14.4	14.4

	Main Tee	Cross Tee	Cross Tee	1000	1100	1200	1000	1100	1200	1000	1100	1200	1000	1100	1200
				Allowable Load (kg/m <sup>2</sup> )											
				DC1H	DC2H	—	30.0	26.9	24.4	46.1	41.6	37.8	46.5	41.9	38.1
DC1H	DC2S	—	30.0	26.9	24.4	46.1	41.6	37.8	46.5	41.9	38.1	34.8	31.3	28.4	28.4
DC1S	DC2H	—	17.2	15.3	13.7	30.4	27.3	24.7	38.1	34.3	31.1	19.1	17.1	15.3	15.3
DC1S	DC2S	—	17.2	15.3	13.7	30.4	27.3	24.7	38.1	34.3	31.1	19.1	17.1	15.3	15.3

# RONDO DONN® 15mm GRID CONFIGURATIONS & LOAD TABLES

Check the allowable ceiling grid load using the column with the preferred suspension system shown.

USING A BULB HOLE	USING A WEB HOLE	USING A DXCL CLIP	USING A DXDF STRAP
<p>Ø 2.5 wire or 719 Hook</p>	<p>Ø 2.5 wire or 719 Hook</p>		<p>(no closer than 10mm to the bulb holes)</p>

		Main Tee Span (mm) ie: Between Hanger Points													
		1000	1100	1200	1000	1100	1200	1000	1100	1200	1000	1100	1200		
<b>F</b> 	Main Tee	Cross Tee	Cross Tee	Allowable Load (kg/m <sup>2</sup> )											
	DC1H	DC2H	—	9.63	9.63	9.63	9.63	9.63	9.63	9.63	9.63	9.63	9.63	9.63	9.63
		DC2S	—	7.57	7.57	7.57	7.57	7.57	7.57	7.57	7.57	7.57	7.57	7.57	7.57
	DC1S	DC2H	—	9.63	9.63	9.63	9.63	9.63	9.63	9.63	9.63	9.63	9.63	9.63	9.63
DC2S		—	7.57	7.57	7.57	7.57	7.57	7.57	7.57	7.57	7.57	7.57	7.57	7.57	

		1000	1100	1200	1000	1100	1200	1000	1100	1200	1000	1100	1200		
<b>G</b> 	Main Tee	Cross Tee	Cross Tee	Allowable Load (kg/m <sup>2</sup> )											
	DC1H	DC2H	—	3.56	3.56	3.56	3.56	3.56	3.56	3.56	3.56	3.56	3.56	3.56	
		DC2S	—	2.30	2.30	2.30	2.30	2.30	2.30	2.30	2.30	2.30	2.30	2.30	
	DC1S	DC2H	—	3.56	3.56	3.56	3.56	3.56	3.56	3.56	3.56	3.56	3.56	3.56	
DC2S		—	2.30	2.30	2.30	2.30	2.30	2.30	2.30	2.30	2.30	2.30	2.30		

		1000	1100	1200	1000	1100	1200	1000	1100	1200	1000	1100	1200		
<b>H</b> 	Main Tee	Cross Tee	Cross Tee	Allowable Load (kg/m <sup>2</sup> )											
	DC1H	DC2H	DC2S	10.9	10.9	10.9	10.9	10.9	10.9	10.9	10.9	10.9	10.9	10.9	
		DC2S	DC2S	8.28	8.28	8.28	8.28	8.28	8.28	8.28	8.28	8.28	8.28	8.28	
	DC1S	DC2H	DC2S	10.9	10.9	10.9	10.9	10.9	10.9	10.9	10.9	10.9	10.9	10.9	
DC2S		DC2S	8.28	8.28	8.28	8.28	8.28	8.28	8.28	8.28	8.28	8.28	8.28		

		1000	1100	1200	1000	1100	1200	1000	1100	1200	1000	1100	1200		
<b>J</b> 	Main Tee	Cross Tee	Cross Tee	Allowable Load (kg/m <sup>2</sup> )											
	DC1H	DC2H	—	30.0	26.9	24.4	46.1	41.6	37.8	46.5	41.9	38.1	34.8	31.3	28.4
		DC2S	—	30.0	26.9	24.4	46.1	41.6	37.8	46.5	41.9	38.1	34.8	31.3	28.4
	DC1S	DC2H	—	17.2	15.3	13.7	30.4	27.3	24.7	38.1	34.3	31.1	19.1	17.1	15.3
DC2S		—	17.2	15.3	13.7	30.4	27.3	24.7	38.1	34.3	31.1	19.1	17.1	15.3	

**NOTES:**

1. Design tables are for internal applications only.
2. Nominated loads are the imposed weight the grid will carry and should include tile weight, insulation and any other known load.
3. Design loads do not need to be factored and can be directly compared to the weight of the ceiling tiles etc.
4. Where imposed weight exceeds design refer to Rondo for further consideration.







we're behind the best buildings