

## WALLS

MAXIFRAME® >

**RONDO®**

# RONDO MAXIFRAME® EXTERNAL WALL FRAMING SYSTEM

## SUMMARY

The Rondo MAXIframe® External Wall Framing system is paving the way for light-weight steel framing in external wall construction. The system has been expertly engineered to offer builders a more efficient, versatile and cost effective design option than traditional external wall framing construction methods.

The system incorporates standard Rondo 92mm Studs as the main framing, with the inclusion of two new major profiles, MAXIjamb® and MAXItrack®, and three complementary cleats to provide a simple, yet solid structure.

## SUITABLE FOR:

- External Wall Systems
- Vented External Walls
- Non-Vented External Walls
- Load Bearing Walls by design
- Window and Door Jamb
- Non-Fire Rated Systems
- Fire Rated Systems
- Dual exterior cladding and interior linings support
- Insulation in wall cavity
- Access for services within outer walls

## SPECIAL FEATURES

- MAXIjamb can support and carry greater load than regular wall studs, therefore removing the need for boxed or back to back stud configurations
- MAXItrack provides a positive connection between stud and deflection head which has allowed the Nogging track normally located 100mm below the head track to be removed
- Greater performance capacities than traditional external wall framing construction methods
- Available in custom lengths
- MAXIjamb is made from hi tensile steel, 1.2BMT G500
- MAXIjamb can be used as both a vertical jamb member around openings, or horizontal head and sill member in window openings.
- Majority of Stud and Track is hemmed for safety and increased strength
- Manufactured with a minimum coating of Z275

## IN PRACTICE

Since its release in 2011, Rondo's MAXIframe External Wall Framing System has already been used in significant projects across Australia and New Zealand. In the **Century Apartments project in Queensland**, the MAXIframe system was used to create a solid framing foundation in all 76 residential units.

## IMPORTANT NOTE:

Rondo recommends its products and systems are installed by a qualified tradesperson and according to the relevant codes and standards outlined on page 256 of this manual.

## CONTENTS:

COMPONENTS	112
SECTION PROPERTIES	
• WALL STUD & MAXIJAMB	113
• DEFLECTION HEAD & WALL TRACK	114
• NOGGING TRACKS & CLEATS	115
DESIGN DATA	
• WIND LOADING & SERVICEABILITY	116
• LOADING ASSUMPTIONS	118
INSTALLATION DETAILS	
• TYPICAL MAXIFRAME SYSTEM	120
• BASE TRACK	121
• SLOTTED DEFLECTION HEAD TRACK	122
• NOGGINGS	123
• JAMB STUDS	124
WALL STUD DESIGN TABLES	
• HOW TO READ THE TABLES	129
• REGION A	130
• REGION B	134
MAXIJAMB DESIGN CHARTS	
• HOW TO USE THE CHARTS	138
• JAMB STUD DESIGN: REGION A	139
• JAMB STUD DESIGN: REGION B	140
MAXIJAMB SILL & HEADER FRAMING	141
MAXIJAMB SILL & HEADER DESIGN	
• REGION A	142
• REGION B	143
ADDITIONAL INFORMATION	
• FAÇADE CLADDING SYSTEMS	144
• DERIVATION OF THE DESIGN PRESSURES	146
• DERIVATION OF THE DESIGN CAPACITIES	147

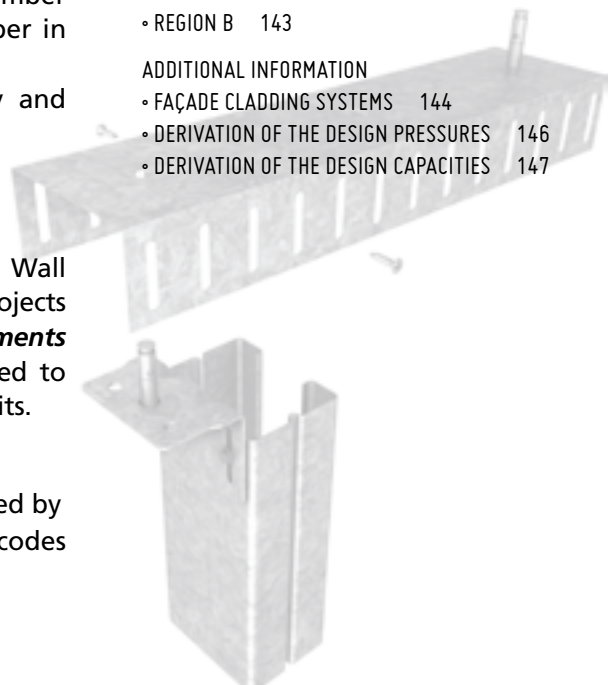

# MAXIFRAME® COMPONENTS

## CLEATS

201	92mm x 2.9mm Base Bracket
202	92mm x 1.5mm Sill Bracket
203	92mm x 2.9mm Slotted Head Bracket

## CLEATS

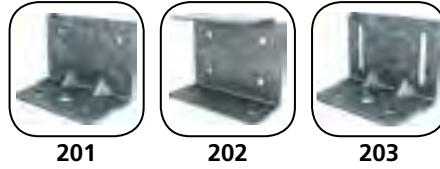

201

202

203

## JAMB STUD

200	MAXIjamb Stud 92mm x 1.20bmt
-----	---------------------------------

## JAMB STUD



200

## SLOTTED DEFLECTION HEAD TRACK

S683	MAXItrack 92mm x 1.15 bmt
------	---------------------------

## SLOTTED DEFLECTION HEAD TRACK



S683

## WALL TRACK

680	92mm x 32mm x 1.15bmt
-----	-----------------------

## WALL TRACK



680

## NOGGING TRACK

506	92mm x 0.70bmt
-----	----------------

## NOGGING TRACK



506

## WALL STUD

681	92mm x 1.15bmt
-----	----------------

## WALL STUD



681

# SECTION PROPERTIES

## Wall Stud & MAXIjamb

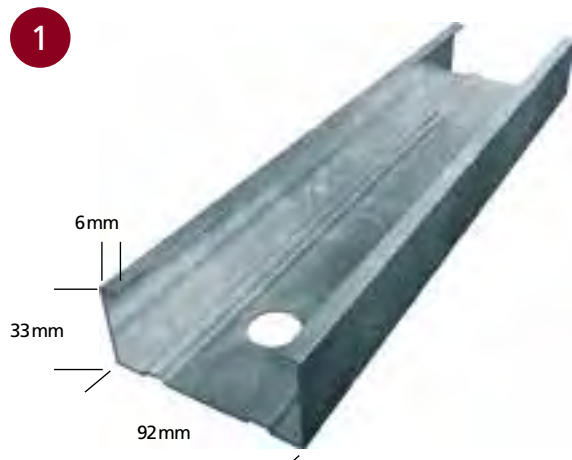

■ 681 WALL STUD



■ 200 MAXIJAMB

TABLE 1: SECTION PROPERTIES

RONDO PART NO	DEPTH (mm)	GAUGE t (mm)	AREA GROSS A (mm <sup>2</sup> )	WEIGHT (kg/m)
681	92.1	1.15	187.8	1.52
200	92.1	1.20	350.6	2.83

RONDO PART NO	MOMENT OF INERTIA (10 <sup>3</sup> mm <sup>4</sup> )		RADIUS OF GYRATION (mm)		CENTROID (mm)		SHEAR CENTRE (mm)	MONO-SYMMETRY CONSTANT (mm)	TORSION CONSTANT (mm <sup>4</sup> )	WARPING CONSTANT (10 <sup>6</sup> mm <sup>6</sup> )
	I <sub>xx</sub>	I <sub>yy</sub>	R <sub>xx</sub>	R <sub>yy</sub>	X <sub>c</sub>	Y <sub>c</sub>	X <sub>o</sub>	β <sub>y</sub>	J	I <sub>w</sub>
681	242.1	25.8	35.9	11.7	8.70	46.0	-22.6	101.2	83.4	40.5
200	492.8	258	37.4	27.1	30.4	46.0	-71.9	156.3	168.3	820

NOTE: Section properties are gross, based on the centerline of the section. Gauge (t) is specified as Base Metal Thickness (BMT).

TABLE 2: DESIGN VALUES

RONDO PART NO	SECTION CAPACITY $\phi M_{sx}$ (kNm)	MEMBER MOMENT CAPACITY $\phi M_{bx}$ (kNm)	DISTORTIONAL MOMENT CAPACITY $\phi M_{bdx}$ (kNm)	SHEAR CAPACITY $\phi V_v$ (kN)	FULL LATERAL RESTRAINT FLR (mm)
681	1.256	Varies	1.1241	12.9	830
200	5.027	Varies	4.129	18.0	1580

## SECTION PROPERTIES (continued)

### Deflection Head & Wall Track

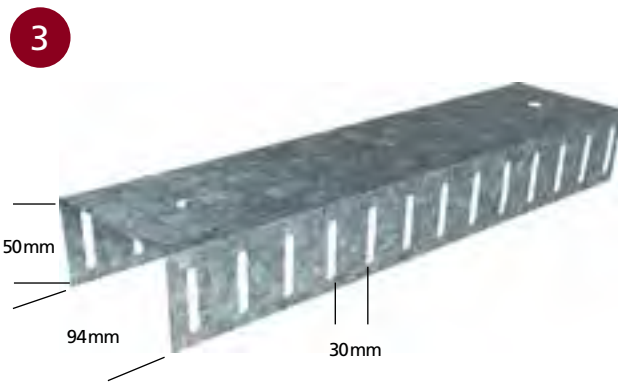

■ S683 MAXITRACK SLOTTED DEFLECTION HEAD TRACK



■ 680 WALL TRACK

TABLE 3: SECTION PROPERTIES

RONDO PART NO	DEPTH (mm)	GAUGE t (mm)	AREA GROSS A (mm <sup>2</sup> )	WEIGHT (kg/m)
S683	94.5	1.15	221	1.61
680	94.5	1.15	176	1.42

RONDO PART NO	MOMENT OF INERTIA (10 <sup>3</sup> mm <sup>4</sup> )		RADIUS OF GYRATION (mm)		CENTROID (mm)		SHEAR CENTRE (mm)	MONO-SYMMETRY (mm)	TORSION CONSTANT (mm <sup>4</sup> )	WARPING CONSTANT (10 <sup>6</sup> mm <sup>6</sup> )
	I <sub>xx</sub>	I <sub>yy</sub>	R <sub>xx</sub>	R <sub>yy</sub>	X <sub>c</sub>	Y <sub>c</sub>	X <sub>o</sub>	β <sub>y</sub>	J	I <sub>w</sub>
S683	318.9	56.3	38.2	16.0	12.9	47.2	-32.0	113.7	96.1	83.8
680	227.2	16.0	35.6	8.9	5.8	47.2	-15.7	108.6	75.8	20.8

NOTE: Section properties are gross, based on the centerline of the section. Gauge (t) is specified as Base Metal Thickness (BMT).

TABLE 4: DESIGN VALUES

RONDO PART NO	SECTION CAPACITY $\phi M_{sx}$ (kNm)	MEMBER MOMENT CAPACITY $\phi M_{bx}$ (kNm)	DISTORTIONAL MOMENT CAPACITY $\phi M_{bdx}$ (kNm)	SHEAR CAPACITY $\phi V_v$ (kN)	FULL LATERAL RESTRAINT FLR (mm)
S683	1.080	Varies	–	12.9	1090
680	0.9823	Varies	–	12.9	690

## Nogging Track & Cleats

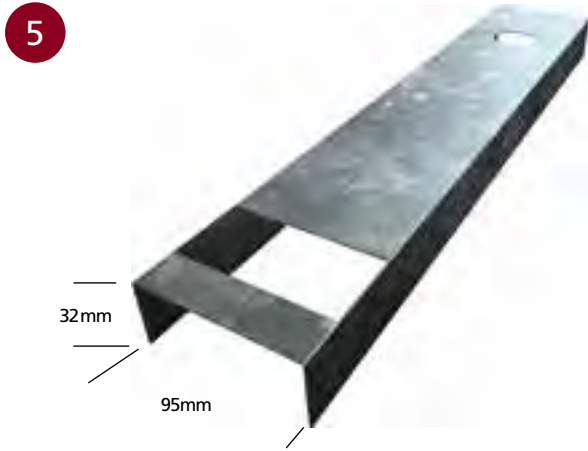

■ 506 NOGGING TRACK



■ 201 JAMB BASE BRACKET

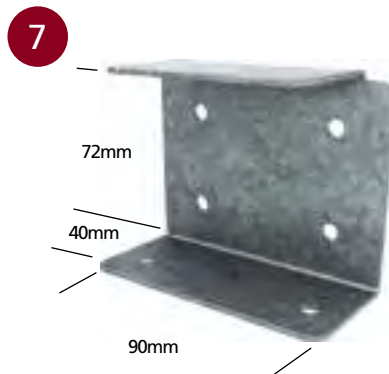

■ 202 SILL/HEADER BRACKET



■ 203 SLOTTED JAMB HEAD BRACKET

**TABLE 5: SECTION PROPERTIES**

RONDO PART NO	DEPTH (mm)	GAUGE t (mm)	AREA GROSS A (mm <sup>2</sup> )	WEIGHT (kg/m)
506	94.5	0.70	107.8	0.86

RONDO PART NO	MOMENT OF INERTIA (10 <sup>3</sup> mm <sup>4</sup> )		RADIUS OF GYRATION (mm)		CENTROID (mm)		SHEAR CENTRE (mm)	MONO-SYMMETRY CONSTANT (mm)	TORSION CONSTANT (mm <sup>4</sup> )	WARPING CONSTANT (10 <sup>6</sup> mm <sup>6</sup> )
	I <sub>xx</sub>	I <sub>yy</sub>	R <sub>xx</sub>	R <sub>yy</sub>	X <sub>c</sub>	Y <sub>c</sub>	X <sub>o</sub>	β <sub>y</sub>	J	I <sub>w</sub>
506	129.8	7.08	35.5	8.2	5.20	47.2	-14.2	110.4	16.8	10.9

NOTE: Section properties are gross, based on the centerline of the section. Gauge (t) is specified as Base Metal Thickness (BMT).

RONDO PART NO	GAUGE t (mm)
201	2.9
202	1.5
203	2.9

# DESIGN DATA

## Wind Loading & Serviceability

The wind loading presented in this manual has been calculated in accordance with AS/NZS1170.2.

A more detailed evaluation of the wind loading may be found on Page 146. Some of the assumptions used in the determination of the design pressures are summarised below:

### BUILDING IMPORTANCE LEVEL

The designer is responsible for checking the building importance level in accordance with the Building Code of Australia (BCA) Section B. The design pressures have been determined based on a Building Importance Level 3, in accordance with the BCA, using a V1000 wind speed.

### REGIONS A & B

The design tables are suitable for checking the MAXIframe systems located within Wind Regions A & B of Australia and New Zealand.

For Australia, Regions A & B cover the vast majority of the country, with the exception of the coastal regions above 25° latitude on the East Coast and 27° latitude on the west coast. (Refer to Figure 9.)

The excluded areas are classified as cyclonic and require significantly higher wind loading to be applied to the framing.

For New Zealand, Region W and the alpine regions are excluded due to the higher wind loading required in these areas. These areas are located between the red contour lines and shading on the map in Figure 9.

In these locations, specific designs will be required and we recommend that you discuss your requirements with your Rondo Technical Representative.

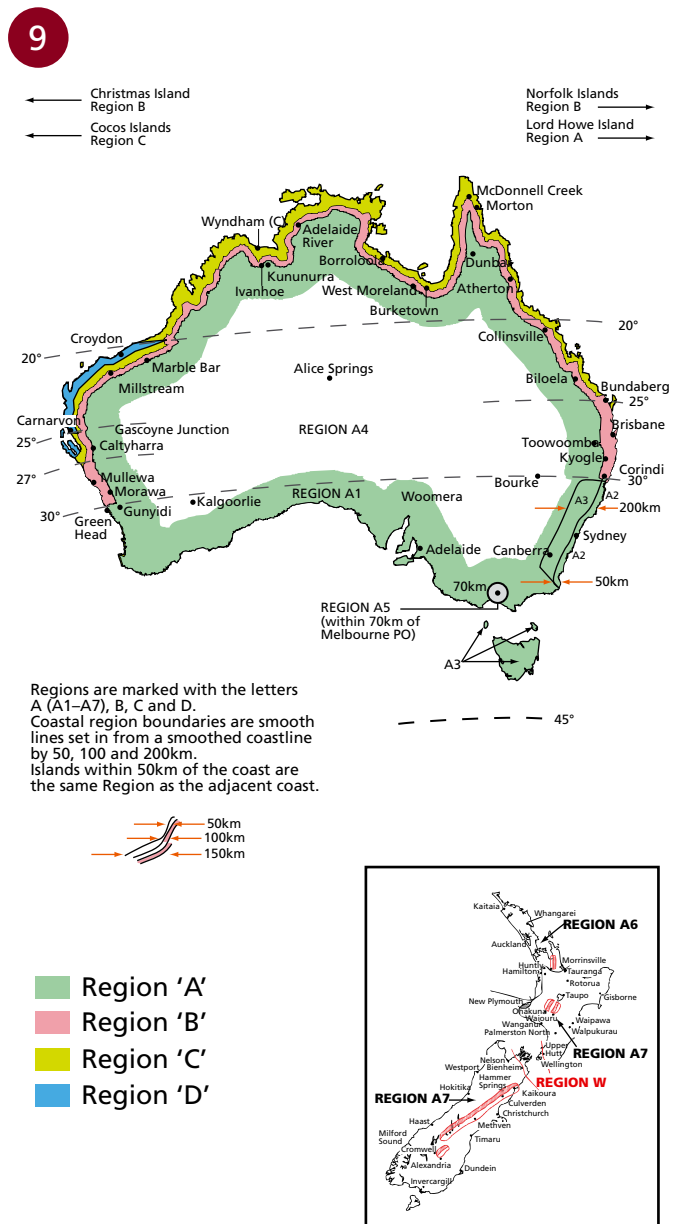

■ WIND REGIONS A & B FOR AUSTRALIA & NEW ZEALAND



## TERRAIN CATEGORIES

The design tables are suitable for checking the MAXIframe systems located in Terrain Categories 3 and 2.5.

Terrain Category 2 has not been considered due to possible differences in terrain categories between ultimate and serviceability and designs for these locations should be referred to your Rondo Technical Representative.

For clarification of Terrain Categories refer to Figure 10.

The design tables for Terrain Category 3 can be used for Terrain Category 4, although this may be conservative

## SERVICEABILITY

The design tables have been prepared for H/240 and H/360 deflection limits, to accommodate both flexible and "brittle" cladding types. Rondo recommends using, as a minimum, the H/360 tables for all brick veneer construction.

The design tables do not consider the wall linings for serviceability, except for lateral restraint (i.e. there is no composite action assumed).

10

### Category 2.5

Terrain with few trees and isolated obstructions.  
This is an intermediate classification between Category 2 and 3.

2.5



### Category 3

Terrain with numerous closely-spaced obstructions such as areas of suburban housing. (3 metres to 5 metres high)

3.0



## TERRAIN CATEGORIES



## DESIGN DATA (continued)

### Loading Assumptions

#### WALL STUDS

The wall stud framing solutions presented in this manual have been determined assuming the unrestrained flange (i.e. unlined flange) is in compression, for both the positive and negative wind pressures. The contributory wall load width has been taken as shown in Figure 11.

#### NOGGINGS

Noggings are assumed to provide lateral and torsional restraint to the studs. At the Nogging location, rotation in a plane perpendicular to the plane of loading (ie; through the minor axis) is assumed to be fixed.

The following Nogging configurations are assumed in the tables:

**1 row mid height:**

Walls up to and including 3000mm high

**2 rows equispaced:**

Walls greater than 3000mm high.

Rondo does not recommend attaching top hats vertically, to the pre-punched 0.70bmt Noggings. Due to the punch out configuration, the Noggings do not have sufficient capacity or rigidity to accommodate laterally imposed loads. Where top hats are required to be installed vertically, Rondo recommends the introduction of a secondary horizontal top hat member.

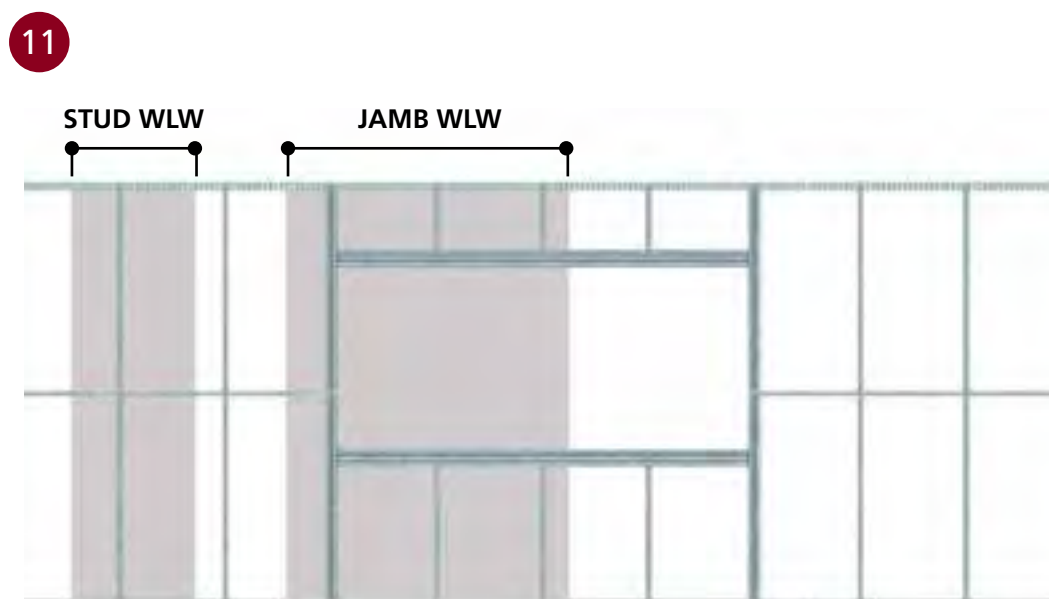

## WALL LININGS

Where the wall linings are fixed to one flange, it is assumed to provide lateral restraint only. Where the wall linings are fixed to both flanges, it is assumed to provide lateral and torsional restraint. The linings may be fixed either vertically or horizontally to the studs; however, the joints in the linings should always be staggered, and the linings should always be installed in accordance with the manufacturer's recommendations.

## FASTENERS

The use of mechanical fasteners, such as self drilling screws, provide a fast and effective means of securing the framing. The design tables assume a certain degree of restraint at the member intersection and connection points, and this can be achieved by screw fastening. Table 6 provides the screw shear capacity, based on tilting and bearing, along with the pullout (tension) capacity, for both #8 and 10# gauge screws.

**TABLE 6: SCREW SHEAR AND PULLOUT CAPACITY**

SCREW GAUGE	8	10	8	10
MINIMUM STEEL THICKNESS	SHEAR CAPACITY $\phi V_b$ kN		PULLOUT CAPACITY $\phi N_{ou}$ kN	
1.15mm	1.75	1.87	0.68	0.77
1.20mm*	2.94	3.14	1.11	1.27

**NOTES:**

- \*  $t = 1.20\text{mm}$   $F_u = 520\text{MPa}$ , all other steel thicknesses  $F_u = 330\text{MPa}$ .
- Screw fasteners to be in accordance with AS3566.
- Screw coating to be selected in accordance with the manufacturer's recommendations.

# INSTALLATION DETAILS

Typical MAXIframe System

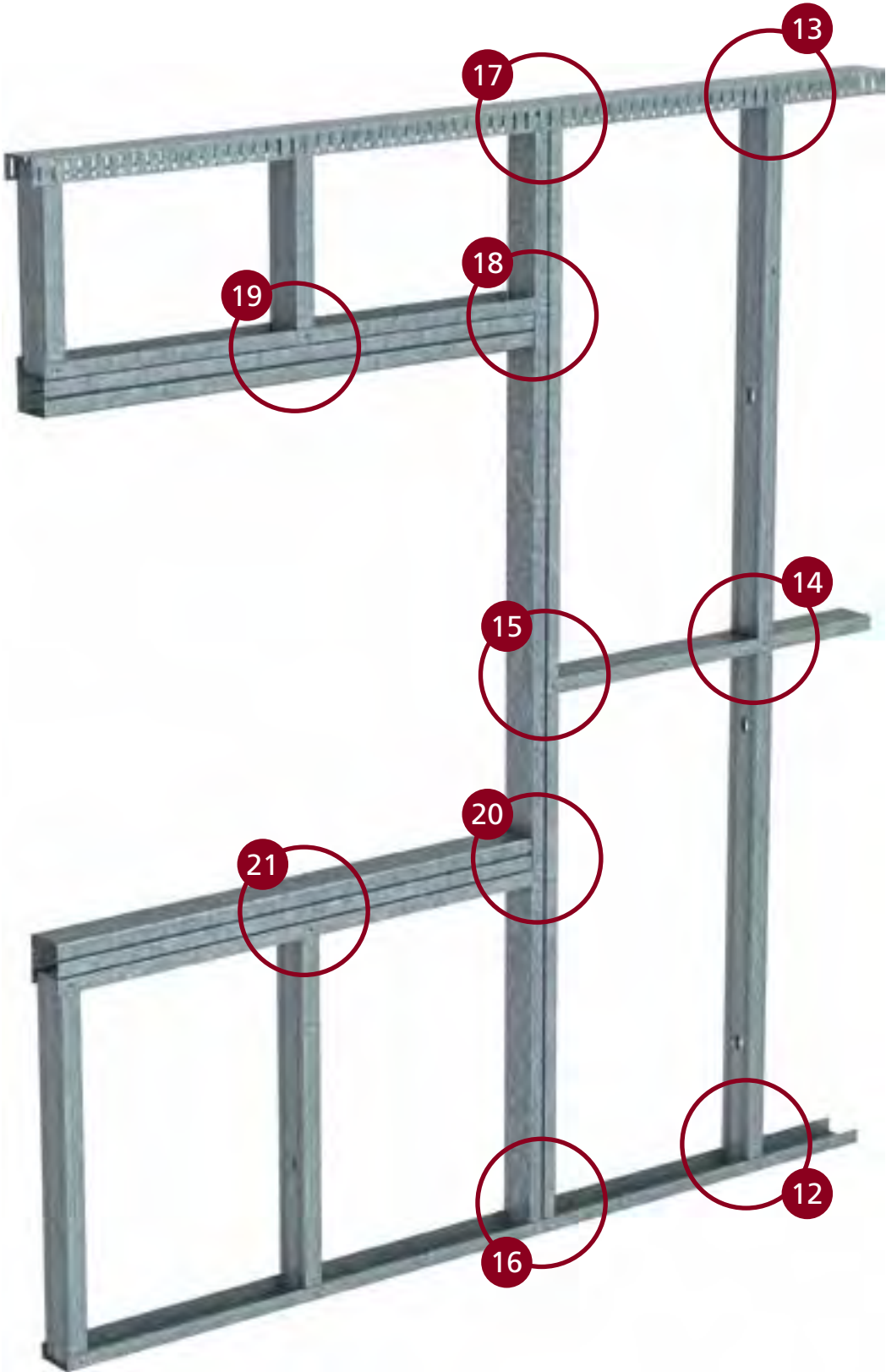

*Circled areas on the drawing refer to figures shown in more detail on the following pages.*

## Base Track

The base track anchor is required to withstand the shear forces resulting from the wind loading onto the face of the wall. The base track anchor is to be independently checked for the minimum capacity specified below.

All Rondo tracks are pre-punched, with a 10.5mm diameter hole at 150mm centres, along their centerline to allow easier installation of the track fasteners. Rondo recommends the maximum spacing of the base track anchors as shown in Table 7.

The fixing between the stud and track is to be a single #8 wafer head tek screw, minimum, per side.

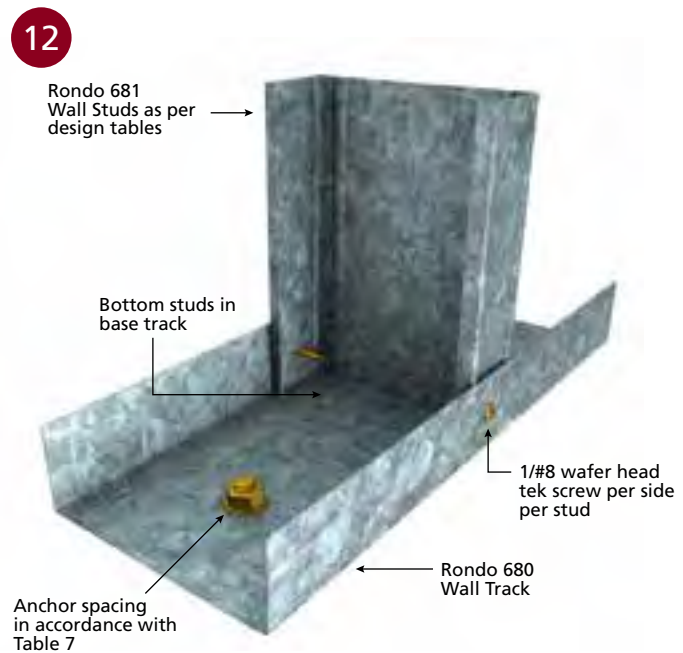

■ TYPICAL BASE TRACK FIXING DETAILS

TABLE 7: MAXIMUM ANCHOR SPACING

ANCHOR SIZE (mm)	ADOPTED SPACING (mm)	MAXIMUM DESIGN PRESSURE (kPa)
8	600	2.50
	450	3.40
	300	5.10

**NOTES:**

1. The above table is based on a maximum wall height of 3.2m.
2. Anchor to be checked for minimum shear capacity of 3.10kN.
3. Anchors to be selected and installed in accordance with manufacturer's recommendations.
4. Minimum edge distance to concrete to be 50mm.
5. Dynabolts to be installed with washers in place.

# INSTALLATION DETAILS (continued)

## Slotted Deflection Head Track

The MAXItrack deflection head track anchors are the same as the base track anchors.

The new MAXItrack is slotted along the flanges, to provide allowance for building vertical movements, and provides a positive connection between the stud and deflection head. This has allowed the Nogging 100mm below the head track to be removed. Consideration of the connection capacity has been accounted for in the wall framing tables. The MAXItrack slotted deflection head connection has greater capacity than the traditional deflection head connection, therefore the wall framing tables in this manual are exclusively for use with the MAXItrack product and system components.

### CONNECTIONS

Connection between the stud and MAXItrack is via 1/#10 wafer head tek screw per side, per stud, as shown.

#### TO CONCRETE:

The standard clearance between the top of the stud and the slab soffit is 20mm, which accommodates up to 15mm incremental slab deflection, with tolerance.

#### TO STEELWORK:

Where the steelwork carries roof or floor loads, a deflection head will be required. Where the steelwork is in place only as lateral support to the stud framing a deflection head is not required.

For roof uplift, the MAXItrack can be installed with an initial stud clearance of 5mm, which will give an allowance of up to 15mm for roof uplift.

#### NOTE:

The allowance for structural movement is to be confirmed by the project engineer prior to commencing work on site.

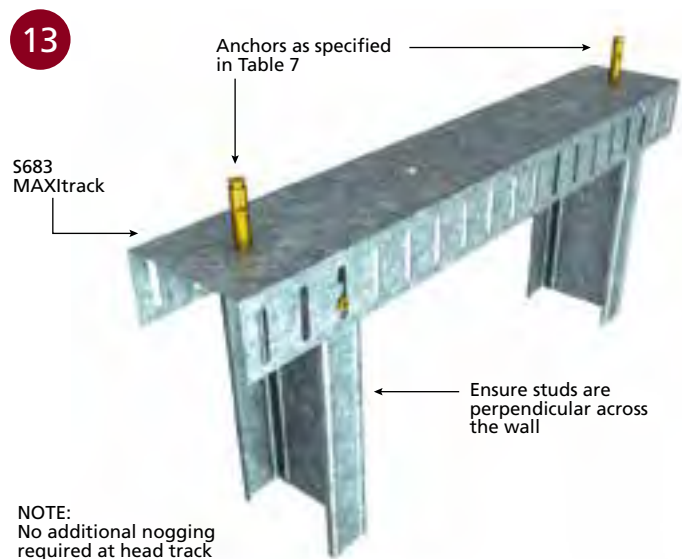

■ TYPICAL MAXITRACK CONNECTION DETAILS

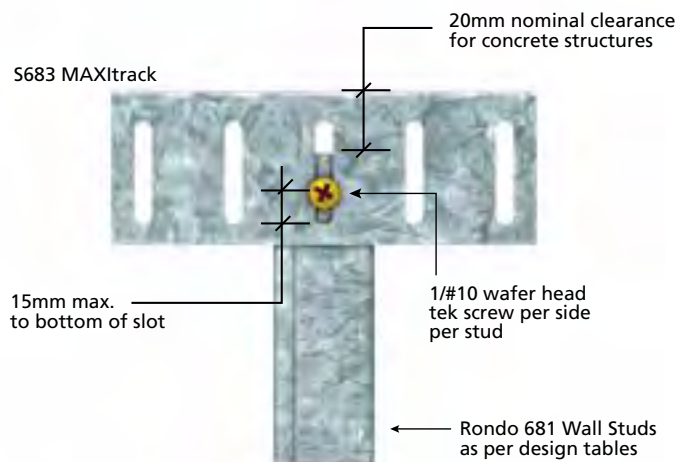

■ TYPICAL MAXITRACK FIXING DETAIL

## Noggings

Noggings are a very important part of the overall stud framing system as they provide lateral and torsional restraint to the wall studs, thereby increasing the load that can be carried by the studs. However, Noggings do not improve the deflection of the framing.

Rondo produces continuous Nogging track, which has pre-punched slots as standard at 450mm and 600mm centres. Other sizes can be ordered as a special.

The Nogging track can be laid over the base track, and after the studs are positioned, slid up the wall and secured in place. Alternatively, individual Noggings may be cut from the continuous track and installed separately.

The Nogging is required to be fastened to each stud using 1/#8 wafer head tek screw.

Noggings are to be installed as noted in Table 8.

14

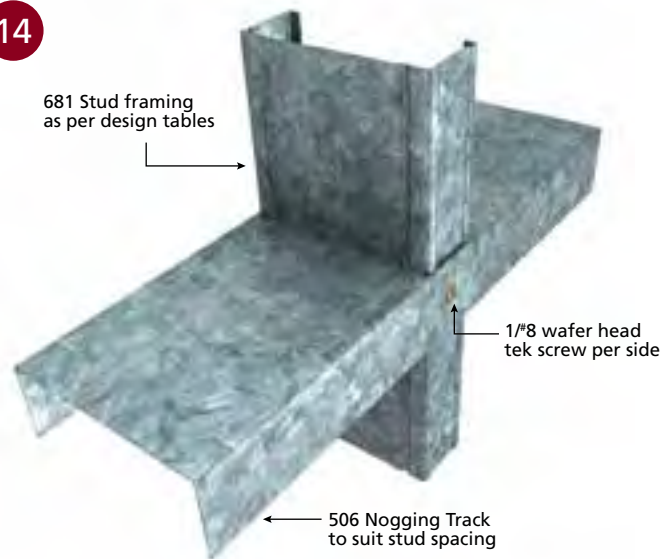

■ TYPICAL NOGGING DETAIL

TABLE 8: NOGGING REQUIREMENTS

WALL HEIGHT (mm)	NOGGINGS REQUIRED
UP TO 3000	1 row mid height
> 3001	2 rows equispaced

15



■ NOGGING TRACK FIXING DETAIL AT MAXIJAMB

# INSTALLATION DETAILS (continued)

## Jamb Studs

### MAXIJAMB BASE CONNECTION

The MAXIjamb base cleats have strengthening gussets in the corners, and have been profiled to match the MAXIjamb and other Rondo products. The cleat capacity has been derived from load testing of the connection. The design charts for the MAXIjamb, have been prepared based on the typical connection shown here.

### FIXING DETAILS

#### TO THE MAXIJAMB SECTION:

Set the face with the two holes against the web of the MAXIjamb, and install using 2/#10 hexagon head tek screws.

**Note: The MAXIjamb base bracket is to be fitted to the MAXIjamb web, unless noted otherwise.**

#### TO CONCRETE:

Use the central hole, in the base of the bracket with a 10mm Expanding Type Anchor, and washer.

#### TO STEELWORK:

Use the central hole with an M10 Grade 4.6 Bolt, and washer under the head.

#### Alternatively:

Use the two outer fixing holes with #12 Series 500 Hexagon Head tek screws.

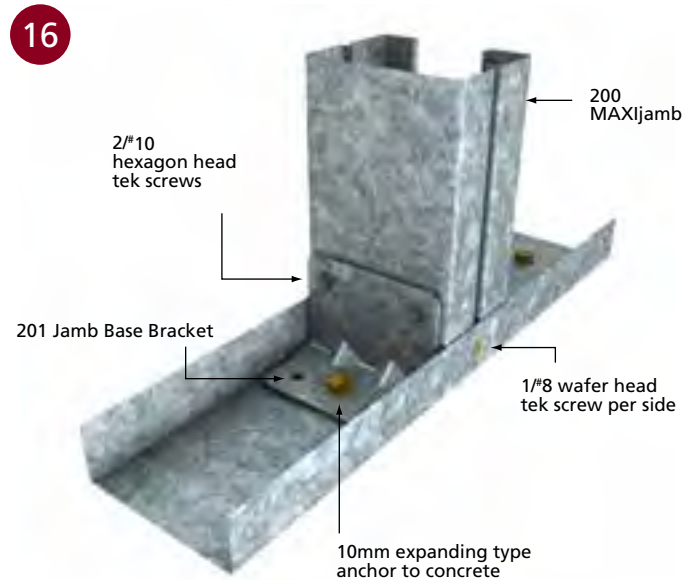

■ TYPICAL MAXIJAMB BASE FIXING DETAILS



### MAXIJAMB HEAD CONNECTION

The MAXIjamb head cleats have strengthening gussets in their corner, and have been profiled to match the MAXIjamb and other Rondo products. The cleat capacity has been derived from actual load testing of the connection.

The design charts for the MAXIjamb, have been prepared based on the typical connection shown here.

### FIXING DETAILS

#### TO THE MAXIJAMB SECTION:

Set the face with the two vertical slots against the web of the MAXIjamb, and install using 2/#10 hexagon head tek screws.

**Note:** The MAXIjamb head bracket is to be fitted to the MAXIjamb web, unless noted otherwise.

#### TO THE STRUCTURE:

The fixing requirements for the MAXIjamb head bracket are the same as for the base bracket on Page 121.

#### TO THE MAXITRACK:

To the MAXIjamb stud, install 1/#10 wafer head tek screw per side.

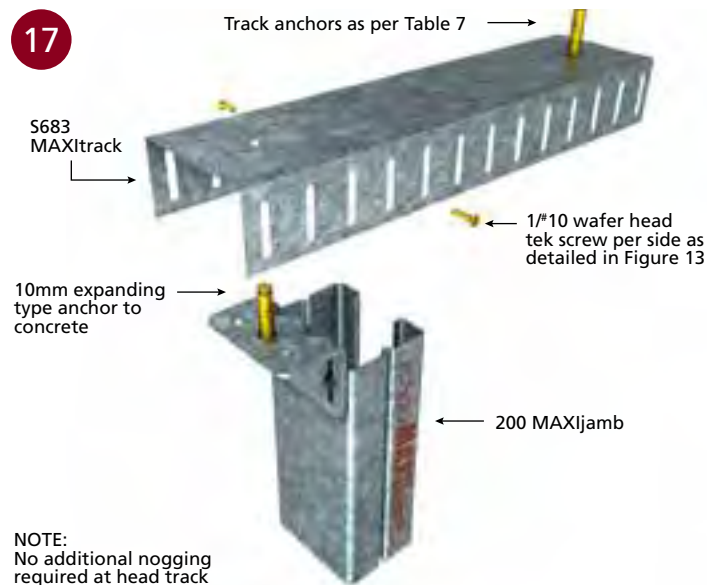

■ EXPLODED VIEW OF MAXIJAMB HEAD CONNECTION

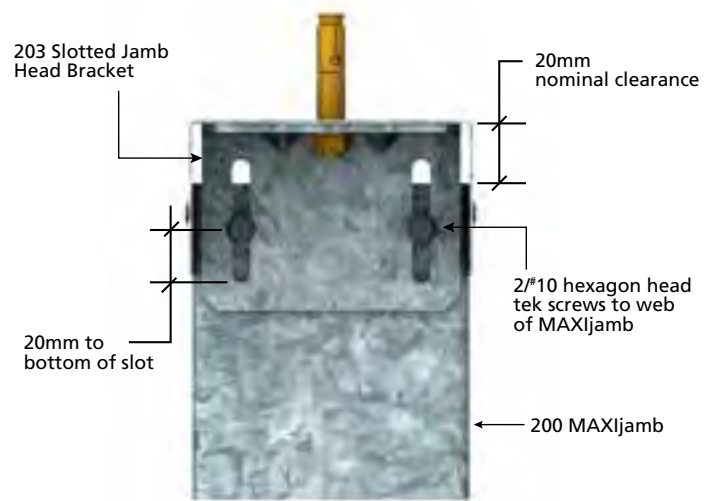

■ FIXING DETAILS FOR MAXIJAMB HEAD

## INSTALLATION DETAILS (continued)

### Jamb Studs (continued)

#### MAXIJAMB 202 SILL & HEADER CONNECTION

The 202 bracket design means one fixing flange is visible and the other invisible. Once the bracket is installed against the web of the MAXIjamb using 4/#10 wafer head tek screws, the MAXIjamb section has to be 'rolled' into place as illustrated (Figures A, B, C).

The exposed flange has two pre-drilled holes for fixing to the MAXIjamb, whilst the flange that is now inside the MAXIjamb should be secured by fixing the screws through the top, 25mm in from the inside jamb face and 25mm from the outer edge of the section (Figure D).

This bracket is fixed to the MAXIjamb with the shorter internal flange facing the opening.

For example: when securing the sill member the short flange faces up and when securing the header, it faces down. (For your convenience, the Rondo 202 Sill/Header Bracket is stamped accordingly on its inner face.)

Once finally secured into place, the outer face of the 202 Sill/Header Bracket will align neatly with the face of the MAXIjamb section, both internally and externally as shown in Figures 18 & 19.

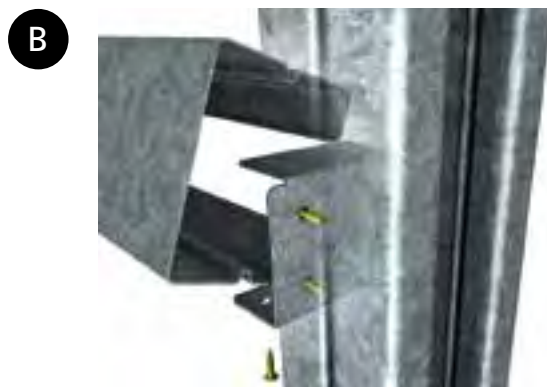

**MAXIJAMB HEAD & SILL MEMBER DETAILS**

Above and/or below openings formed with the MAXIjamb profile, whether it is used as a head or sill member, require securing to the MAXIjamb with standard 92mm track screwed to it and "jack" studs screwed off appropriately (see Figures 18-21).



# INSTALLATION DETAILS (continued)

## Jamb Studs (continued)

The jamb studs are located immediately adjacent to the window or door opening, such that they support and carry the wind loading applied across the width of the wall opening. The load carried by the jamb stud is significantly greater than that carried by the wall studs, which accordingly requires strengthening of the jamb.

### MULTIPLE STUD SECTIONS

Whilst the MAXIframe system will provide a faster and more cost-effective construction solution, the multiple stud method may still apply from time to time and is shown for comparative purposes. Typically, strengthening of the jamb studs was achieved by using multiple stud sections, either boxed together or fixed back-to-back (refer Figure 22).

The MAXIJamb uses a similar mass of steel as a double 92 x 1.15bmt lipped stud section, however, the section performance has been improved by using high tensile steel (G500) and carefully redistributing the steel within the profile (refer Figures 23 & 24).

### MAXIMUM OPENING WIDTHS

When using multiple studs to frame openings, the number of jamb studs required can be determined based on the number of studs in the adjoining wall section. Table 9 may be used to determine the number of stud sections, either side of a wall opening, based on the maximum spacing of the studs in the adjoining wall framing.

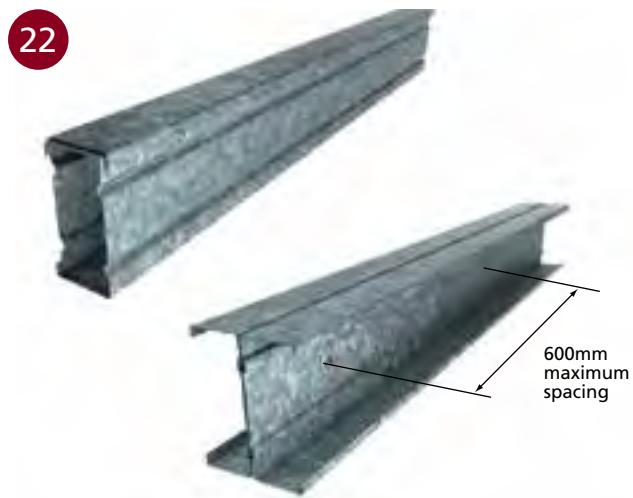

■ BOXED AND BACK-TO-BACK STUD SECTIONS



■ MAXIJAMB



■ TYPICAL STUD FRAMING SECTIONS

TABLE 9: MULTIPLE STUDS TO OPENINGS (WHEN NOT USING MAXIJAMB)

STUD SPACING (mm)	NUMBER OF WALL STUDS EITHER SIDE OF OPENING													
	OPENING WIDTH (MM)													
	600	900	1200	1500	1800	2100	2400	2700	3000	3300	3600	3900	4200	
300	2	2	3	3	4	4	-	-	-	-	-	-	-	
400	2	2	2	3	3	4	4	4	-	-	-	-	-	
450	2	2	2	3	3	3	4	4	4	-	-	-	-	
600	1	2	2	2	2	3	3	3	3	4	4	4	4	

NOTES:

1. The specified studs are the Rondo 92 x 1.15bmt lipped studs.
2. Where more than two (2) studs are specified, they shall be configured as boxed studs plus one stud back to back or double boxed studs.
3. Back to back studs are to be fixed together at 600mm maximum centres using #10 tek screws.

# WALL STUD DESIGN TABLES

## How to read the tables

The wall stud framing tables are configured as shown in Figure 25.

### EXAMPLE:

Using the data below, refer to Figure 26.

### DATA:

Region A Terrain Category 3

Brick veneer construction so adopt H/360 deflection limits

Slab thickness allowance = 200mm

Check the stud framing for the second floor

- Overall building height: 18m (less than 21m therefore OK)
- Check ground level: RL 19.00  
In terms of the tables RL 19.00 equals 0 height
- Check second floor height: This can be done simply by summing the floor heights, which gives:  
 $z = (3 \times 3) + (3 / 2) = 10.5\text{m}$  (above ground level)

**Round this up to 11m**

- Check wall height:  
Floor to floor = 3m  
slab thickness = 200m  
Wall height = 2.8m
- Check Framing in General Areas:  
Refer to Table 12 on page 132 and, using the 11m height (Gen), the frame can be checked as follows:

#### Stud Framing:

92 x 1.15bmt lipped studs

600mm centres generally.

1 row of Nogging as the wall height is less than 3.0m.

#### Head Track:

92 x 50 x 1.15bmt Slotted

Deflection Head Track.

#### Base Track:

92 x 30 x 1.15bmt Wall Track standard.

- Check Framing in Corner Zone  
Overall Building Height: 18m  
Refer to Table 12 on page 132 using 18m (CnrA) the frame can be checked as follows:

#### Stud Framing:

92x1.15bmt Lipped Studs

450 centres maximum

Head & Base Tracks as specified above.

25

		11		Height to centre of wall above ground level. Reference $Z_H$
ZONE		Gen	Cnr A	Location on Building. Reference WA1 & SA2 respectively
Pult		1.17	1.35	
Pser		0.76	0.87	Ultimate and Serviceability Design Pressures
STUD HEIGHT (m)	2.5	600	600	
	2.6	600	600	
	2.7	600	600	
	2.8	600	450	
	2.9	450	450	Maximum height of stud framing in m

EXTRACT OF CONFIGURATION OF WALL STUD FRAMING TABLES, FROM PAGES 130 ON

26

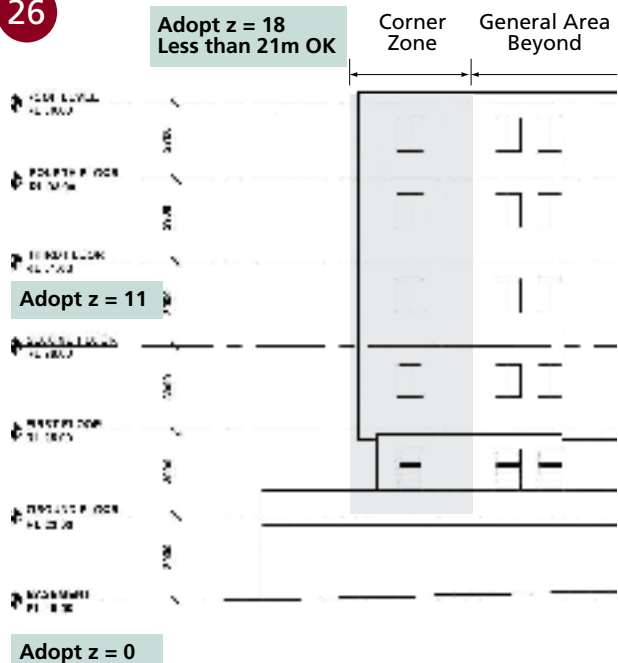

EXAMPLE

# WALL STUD DESIGN TABLES

## Region A

TABLE 10: REGION A: TERRAIN CATEGORY 3 — H/240

		HEIGHT TO CENTRE OF WALL ABOVE "GROUND LEVEL" (m)											
		10		11		12		13		14		15	
ZONE		Gen	Cnr A	Gen	Cnr A	Gen	Cnr A	Gen	Cnr A	Gen	Cnr A	Gen	Cnr A
Pult		1.14	1.31	1.17	1.35	1.20	1.39	1.24	1.43	1.27	1.47	1.31	1.51
Pser		0.74	0.85	0.76	0.87	0.78	0.90	0.80	0.92	0.82	0.95	0.85	0.98
STUD HEIGHT (m)	2.5	600	600	600	600	600	600	600	600	600	600	600	600
	2.6	600	600	600	600	600	600	600	600	600	600	600	600
	2.7	600	600	600	600	600	600	600	600	600	600	600	600
	2.8	600	600	600	600	600	600	600	600	600	600	600	600
	2.9	600	600	600	600	600	600	600	600	600	600	600	600
	3.0	600	600	600	600	600	600	600	600	600	450	600	450
	3.1	600	600	600	600	600	450	600	450	600	450	600	450
	3.2	600	450	600	450	600	450	600	450	450	450	450	450

		HEIGHT TO CENTRE OF WALL ABOVE "GROUND LEVEL" (m)											
		16		17		18		19		20		21	
ZONE		Gen	Cnr A	Gen	Cnr A	Gen	Cnr A	Gen	Cnr A	Gen	Cnr A	Gen	Cnr A
Pult		1.34	1.54	1.37	1.58	1.40	1.61	1.43	1.65	1.46	1.68	1.48	1.70
Pser		0.86	1.00	0.88	1.02	0.90	1.04	0.92	1.07	0.94	1.09	0.96	1.10
STUD HEIGHT (m)	2.5	600	600	600	600	600	600	600	600	600	600	600	600
	2.6	600	600	600	600	600	600	600	600	600	600	600	600
	2.7	600	600	600	600	600	600	600	600	600	600	600	600
	2.8	600	600	600	600	600	600	600	600	600	600	600	600
	2.9	600	600	600	450	600	450	600	450	600	450	600	450
	3.0	600	450	600	450	600	450	600	450	450	450	450	450
	3.1	600	450	600	450	450	450	450	450	450	450	450	450
	3.2	450	450	450	450	450	450	450	450	450	400	450	400

**NOTES:**

- Where the Stud spacing is specified as "NIA", contact a Rondo Technical Sales Representative.
- One (1) row of Nogging for wall heights up to and including 3.0m, two (2) rows of Nogging for wall heights over 3.0m high.

**RONDO DESIGN PARAMETERS:**

• 92 x 1.15mm BMT G2 Lipped Studs • Standard studs and tracks, with Slotted Deflection Head Tracks • Overall Building Height must be less than 21m.

**WIND LOADING PARAMETERS:**

$V_R = 46 \text{ m/s}$

$C_{pe} = 0.8, -0.65$

$C_{pi} = -0.3, 0.2$

$K_I = 1.5$  for General Wall areas in accordance with AS/NZS1170.2:2011 Cl 5.4.4

$K_I$  for Corner Zones as appropriate T5.6 (AS/NZS1170.2:2011)

$M_z, cat$  assumed to vary with height



**TABLE 11: REGION A: TERRAIN CATEGORY 2.5 — H/240**

		HEIGHT TO CENTRE OF WALL ABOVE "GROUND LEVEL" (m)											
		10		11		12		13		14		15	
ZONE		Gen	Cnr A	Gen	Cnr A	Gen	Cnr A	Gen	Cnr A	Gen	Cnr A	Gen	Cnr A
Pult		<b>1.38</b>	<b>1.59</b>	<b>1.42</b>	<b>1.63</b>	<b>1.45</b>	<b>1.67</b>	<b>1.48</b>	<b>1.71</b>	<b>1.52</b>	<b>1.75</b>	<b>1.55</b>	<b>1.79</b>
Pser		<b>0.89</b>	<b>1.03</b>	<b>0.92</b>	<b>1.06</b>	<b>0.94</b>	<b>1.08</b>	<b>0.96</b>	<b>1.11</b>	<b>0.98</b>	<b>1.13</b>	<b>1.00</b>	<b>1.16</b>
STUD HEIGHT (m)	2.5	<b>600</b>	<b>600</b>	<b>600</b>	<b>600</b>	<b>600</b>	<b>600</b>	<b>600</b>	<b>600</b>	<b>600</b>	<b>600</b>	<b>600</b>	<b>600</b>
	2.6	600	600	600	600	600	600	600	600	600	600	600	600
	2.7	600	600	600	600	600	600	600	600	600	600	600	600
	2.8	600	600	600	600	600	600	600	600	600	450	600	450
	2.9	600	450	600	450	600	450	600	450	600	450	600	450
	3.0	600	450	600	450	450	450	450	450	450	450	450	450
	3.1	450	450	450	450	450	450	450	450	450	450	450	450
	3.2	450	450	450	450	450	400	450	400	450	400	450	400

		HEIGHT TO CENTRE OF WALL ABOVE "GROUND LEVEL" (m)											
		16		17		18		19		20		21	
ZONE		Gen	Cnr A	Gen	Cnr A	Gen	Cnr A	Gen	Cnr A	Gen	Cnr A	Gen	Cnr A
Pult		<b>1.58</b>	<b>1.82</b>	<b>1.60</b>	<b>1.85</b>	<b>1.63</b>	<b>1.88</b>	<b>1.66</b>	<b>1.91</b>	<b>1.68</b>	<b>1.94</b>	<b>1.70</b>	<b>1.96</b>
Pser		<b>1.02</b>	<b>1.18</b>	<b>1.04</b>	<b>1.20</b>	<b>1.06</b>	<b>1.22</b>	<b>1.07</b>	<b>1.24</b>	<b>1.09</b>	<b>1.26</b>	<b>1.10</b>	<b>1.27</b>
STUD HEIGHT (m)	2.5	<b>600</b>	<b>600</b>	<b>600</b>	<b>600</b>	<b>600</b>	<b>600</b>	<b>600</b>	<b>600</b>	<b>600</b>	<b>600</b>	<b>600</b>	<b>600</b>
	2.6	600	600	600	600	600	600	600	600	600	600	600	600
	2.7	600	600	600	600	600	600	600	450	600	450	600	450
	2.8	600	450	600	450	600	450	600	450	600	450	600	450
	2.9	450	450	450	450	450	450	450	450	450	450	450	450
	3.0	450	450	450	450	450	450	450	400	450	400	450	400
	3.1	450	450	450	400	450	400	450	400	450	400	450	400
	3.2	450	400	450	400	450	300	450	300	400	300	400	300

**NOTES:**

1. Where the Stud spacing is specified as "NIA", contact a Rondo Technical Sales Representative.
2. One (1) row of Nogging for wall heights up to and including 3.0m, two (2) rows of Nogging for wall heights over 3.0m high.

**RONDO DESIGN PARAMETERS:**

• 92 x 1.15mm BMT G2 Lipped Studs • Standard studs and tracks, with Slotted Deflection Head Tracks • Overall Building Height must be less than 21m.

**WIND LOADING PARAMETERS:**

$V_R = 46 \text{ m/s}$

$C_{pe} = 0.8, -0.65$

$C_{pi} = -0.3, 0.2$

$K_I = 1.5$  for General Wall areas in accordance with AS/NZS1170.2:2011 Cl 5.4.4

$K_I$  for Corner Zones as appropriate T5.6 (AS/NZS1170.2:2011)

$M_z, cat$  assumed to vary with height



# WALL STUD DESIGN TABLES

Region A (continued)

TABLE 12: REGION A: TERRAIN CATEGORY 3 — H/360

		HEIGHT TO CENTRE OF WALL ABOVE "GROUND LEVEL" (m)											
		10		11		12		13		14		15	
ZONE		Gen	Cnr A	Gen	Cnr A	Gen	Cnr A	Gen	Cnr A	Gen	Cnr A	Gen	Cnr A
Pult		1.14	1.31	1.17	1.35	1.20	1.39	1.24	1.43	1.27	1.47	1.31	1.51
Pser		0.74	0.85	0.76	0.87	0.78	0.90	0.80	0.92	0.82	0.95	0.85	0.98
STUD HEIGHT (m)	2.5	600	600	600	600	600	600	600	600	600	600	600	600
	2.6	600	600	600	600	600	600	600	600	600	600	600	600
	2.7	600	600	600	600	600	450	600	450	600	450	600	450
	2.8	600	450	600	450	600	450	600	450	450	450	450	450
	2.9	450	450	450	450	450	450	450	450	450	450	450	400
	3.0	450	450	450	400	450	400	450	400	450	400	450	400
	3.1	450	400	450	400	450	300	400	300	400	300	400	300
	3.2	400	300	400	300	400	300	400	300	300	300	300	300

		HEIGHT TO CENTRE OF WALL ABOVE "GROUND LEVEL" (m)											
		16		17		18		19		20		21	
ZONE		Gen	Cnr A	Gen	Cnr A	Gen	Cnr A	Gen	Cnr A	Gen	Cnr A	Gen	Cnr A
Pult		1.34	1.54	1.37	1.58	1.40	1.61	1.43	1.65	1.46	1.68	1.48	1.70
Pser		0.86	1.00	0.88	1.02	0.90	1.04	0.92	1.07	0.94	1.09	0.96	1.10
STUD HEIGHT (m)	2.5	600	600	600	600	600	600	600	600	600	600	600	600
	2.6	600	600	600	450	600	450	600	450	600	450	600	450
	2.7	600	450	600	450	450	450	450	450	450	450	450	450
	2.8	450	450	450	450	450	450	450	450	450	450	400	450
	2.9	450	400	450	400	450	400	450	400	450	300	450	300
	3.0	450	300	400	300	400	300	400	300	400	300	400	300
	3.1	400	300	400	300	300	300	300	300	300	300	300	300
	3.2	300	300	300	300	300	300	300	300	300	300	N/A	300

**NOTES:**

- Where the Stud spacing is specified as "N/A", contact a Rondo Technical Sales Representative.
- One (1) row of Nogging for wall heights up to and including 3.0m, two (2) rows of Nogging for wall heights over 3.0m high.

**RONDO DESIGN PARAMETERS:**

• 92 x 1.15mm BMT G2 Lipped Studs • Standard studs and tracks, with Slotted Deflection Head Tracks • Overall Building Height must be less than 21m.

**WIND LOADING PARAMETERS:**

$V_R = 46 \text{ m/s}$

$C_{pe} = 0.8, -0.65$

$C_{pi} = -0.3, 0.2$

$K_I = 1.5$  for General Wall areas in accordance with AS/NZS1170.2:2011 Cl 5.4.4

$K_I$  for Corner Zones as appropriate T5.6 (AS/NZS1170.2:2011)

$M_z, cat$  assumed to vary with height  $K_I = 1.25$  for General Wall areas in accordance with AS/NZS1170.2:2002 Cl 5.4.4

**TABLE 13: REGION A: TERRAIN CATEGORY 2.5 — H/360**

		HEIGHT TO CENTRE OF WALL ABOVE "GROUND LEVEL" (m)											
		10		11		12		13		14		15	
ZONE		Gen	Cnr A	Gen	Cnr A	Gen	Cnr A	Gen	Cnr A	Gen	Cnr A	Gen	Cnr A
Pult		<b>1.38</b>	<b>1.59</b>	<b>1.42</b>	<b>1.63</b>	<b>1.45</b>	<b>1.67</b>	<b>1.48</b>	<b>1.71</b>	<b>1.52</b>	<b>1.75</b>	<b>1.55</b>	<b>1.79</b>
Pser		<b>0.89</b>	<b>1.03</b>	<b>0.92</b>	<b>1.06</b>	<b>0.94</b>	<b>1.08</b>	<b>0.96</b>	<b>1.11</b>	<b>0.98</b>	<b>1.13</b>	<b>1.00</b>	<b>1.16</b>
STUD HEIGHT (m)	2.5	<b>600</b>	<b>600</b>	<b>600</b>	<b>600</b>	<b>600</b>	<b>600</b>	<b>600</b>	<b>600</b>	<b>600</b>	<b>450</b>	<b>600</b>	<b>450</b>
	2.6	600	450	600	450	600	450	600	450	600	450	450	450
	2.7	600	450	450	450	450	450	450	450	450	450	450	450
	2.8	450	450	450	450	450	400	450	400	450	400	450	400
	2.9	450	400	450	400	450	400	450	300	400	300	400	300
	3.0	400	300	400	300	400	300	400	300	300	300	300	300
	3.1	300	300	300	300	300	300	300	300	300	300	300	300
	3.2	300	300	300	300	300	N/A	300	N/A	300	N/A	300	N/A

		HEIGHT TO CENTRE OF WALL ABOVE "GROUND LEVEL" (m)											
		16		17		18		19		20		21	
ZONE		Gen	Cnr A	Gen	Cnr A	Gen	Cnr A	Gen	Cnr A	Gen	Cnr A	Gen	Cnr A
Pult		<b>1.58</b>	<b>1.82</b>	<b>1.60</b>	<b>1.85</b>	<b>1.63</b>	<b>1.88</b>	<b>1.66</b>	<b>1.91</b>	<b>1.68</b>	<b>1.94</b>	<b>1.70</b>	<b>1.96</b>
Pser		<b>1.02</b>	<b>1.18</b>	<b>1.04</b>	<b>1.20</b>	<b>1.06</b>	<b>1.22</b>	<b>1.07</b>	<b>1.24</b>	<b>1.09</b>	<b>1.26</b>	<b>1.10</b>	<b>1.27</b>
STUD HEIGHT (m)	2.5	<b>600</b>	<b>450</b>	<b>600</b>	<b>450</b>	<b>600</b>	<b>450</b>	<b>600</b>	<b>450</b>	<b>600</b>	<b>450</b>	<b>600</b>	<b>450</b>
	2.6	450	450	450	450	450	450	450	450	450	450	450	450
	2.7	450	450	450	400	450	400	450	400	450	400	450	400
	2.8	450	400	450	400	450	300	400	300	400	300	400	300
	2.9	400	300	400	300	400	300	400	300	300	300	300	300
	3.0	300	300	300	300	300	300	300	300	300	300	300	300
	3.1	300	300	300	N/A	300	N/A	300	N/A	300	N/A	300	N/A
	3.2	300	N/A	300	N/A	300	N/A	300	N/A	N/A	N/A	N/A	N/A

**NOTES:**

- Where the Stud spacing is specified as "N/A", contact a Rondo Technical Sales Representative.
- One (1) row of Nogging for wall heights up to and including 3.0m, two (2) rows of Nogging for wall heights over 3.0m high.

**RONDO DESIGN PARAMETERS:**

• 92 x 1.15mm BMT G2 Lipped Studs • Standard studs and tracks, with Slotted Deflection Head Tracks • Overall Building Height must be less than 21m.

**WIND LOADING PARAMETERS:**

VR = 46 m/s

Cpe = 0.8, -0.65

Cpi = -0.3, 0.2

KI=1.5 for General Wall areas in accordance with AS/NZS1170.2:2011 Cl 5.4.4

KI for Corner Zones as appropriate T5.6 (AS/NZS1170.2:2011)

Mz,cat assumed to vary with height

# WALL STUD DESIGN TABLES

## Region B

TABLE 14: REGION B: TERRAIN CATEGORY 3 — H/240

		HEIGHT TO CENTRE OF WALL ABOVE "GROUND LEVEL" (m)											
		10		11		12		13		14		15	
ZONE		Gen	Cnr A	Gen	Cnr A	Gen	Cnr A	Gen	Cnr A	Gen	Cnr A	Gen	Cnr A
Pult		1.93	2.23	1.99	2.30	2.05	2.36	2.11	2.43	2.16	2.50	2.22	2.57
Pser		0.78	0.90	0.80	0.92	0.82	0.95	0.84	0.97	0.87	1.00	0.89	1.03
STUD HEIGHT (m)	2.5	600	600	600	450	600	450	600	450	600	450	600	450
	2.6	600	450	600	450	600	450	450	450	450	450	450	450
	2.7	450	450	450	450	450	450	450	450	450	450	450	400
	2.8	450	450	450	450	450	400	450	400	450	400	450	400
	2.9	450	400	450	400	450	300	400	300	400	300	400	300
	3.0	400	300	400	300	400	300	400	300	300	300	300	300
	3.1	450	400	450	400	450	300	400	300	400	300	400	300
	3.2	450	300	400	300	400	300	400	300	400	300	300	300

		HEIGHT TO CENTRE OF WALL ABOVE "GROUND LEVEL" (m)											
		16		17		18		19		20		21	
ZONE		Gen	Cnr A	Gen	Cnr A	Gen	Cnr A	Gen	Cnr A	Gen	Cnr A	Gen	Cnr A
Pult		2.27	2.62	2.33	2.68	2.38	2.74	2.43	2.80	2.48	2.86	2.51	2.90
Pser		0.91	1.05	0.93	1.08	0.95	1.10	0.97	1.12	1.00	1.15	1.01	1.16
STUD HEIGHT (m)	2.5	600	450	450	450	450	450	450	450	450	450	450	450
	2.6	450	450	450	450	450	450	450	400	450	400	450	400
	2.7	450	400	450	400	450	400	450	400	450	300	450	300
	2.8	450	300	400	300	400	300	400	300	400	300	400	300
	2.9	400	300	400	300	300	300	300	300	300	300	300	300
	3.0	300	300	300	300	300	300	300	300	300	N/A	300	N/A
	3.1	400	300	400	300	300	300	300	300	300	300	300	300
	3.2	300	300	300	300	300	300	300	300	300	300	300	300

**NOTES:**

- Where the Stud spacing is specified as "N/A", contact a Rondo Technical Sales Representative.
- One (1) row of Nogging for wall heights up to and including 3.0m, two (2) rows of Nogging for wall heights over 3.0m high.

**RONDO DESIGN PARAMETERS:**

• 92 x 1.15mm BMT G2 Lipped Studs • Standard studs and tracks, with Slotted Deflection Head Tracks • Overall Building Height must be less than 21m.

**WIND LOADING PARAMETERS:**

VR = 60 m/s

C<sub>pe</sub> = 0.8, -0.65

C<sub>pi</sub> = -0.3, 0.2

K<sub>I</sub> = 1.5 for General Wall areas in accordance with AS/NZS1170.2:2011 Cl 5.4.4

K<sub>I</sub> for Corner Zones as appropriate T5.6 (AS/NZS1170.2:2011)

M<sub>z,cat</sub> assumed to vary with height

**TABLE 15: REGION B: TERRAIN CATEGORY 2.5 — H/240**

		HEIGHT TO CENTRE OF WALL ABOVE "GROUND LEVEL" (m)											
		10		11		12		13		14		15	
ZONE		Gen	Cnr A	Gen	Cnr A	Gen	Cnr A	Gen	Cnr A	Gen	Cnr A	Gen	Cnr A
Pult		<b>2.35</b>	<b>2.71</b>	<b>2.41</b>	<b>2.78</b>	<b>2.47</b>	<b>2.84</b>	<b>2.52</b>	<b>2.91</b>	<b>2.58</b>	<b>2.98</b>	<b>2.64</b>	<b>3.05</b>
Pser		<b>0.94</b>	<b>1.09</b>	<b>0.97</b>	<b>1.11</b>	<b>0.99</b>	<b>1.14</b>	<b>1.01</b>	<b>1.17</b>	<b>1.04</b>	<b>1.20</b>	<b>1.06</b>	<b>1.22</b>
STUD HEIGHT (m)	2.5	<b>450</b>	<b>450</b>	<b>450</b>	<b>450</b>	<b>450</b>	<b>450</b>	<b>450</b>	<b>450</b>	<b>450</b>	<b>450</b>	<b>450</b>	<b>450</b>
	2.6	450	450	450	400	450	400	450	400	450	400	450	400
	2.7	450	400	450	400	450	400	450	300	400	300	400	300
	2.8	400	300	400	300	400	300	400	300	400	300	300	300
	2.9	300	300	300	300	300	300	300	300	300	300	300	300
	3.0	300	300	300	300	300	300	300	N/A	300	N/A	300	N/A
	3.1	300	300	300	300	300	300	300	300	300	300	300	300
	3.2	300	300	300	300	300	300	300	300	300	N/A	300	N/A

		HEIGHT TO CENTRE OF WALL ABOVE "GROUND LEVEL" (m)											
		16		17		18		19		20		21	
ZONE		Gen	Cnr A	Gen	Cnr A	Gen	Cnr A	Gen	Cnr A	Gen	Cnr A	Gen	Cnr A
Pult		<b>2.69</b>	<b>3.10</b>	<b>2.73</b>	<b>3.15</b>	<b>2.77</b>	<b>3.20</b>	<b>2.82</b>	<b>3.25</b>	<b>2.86</b>	<b>3.31</b>	<b>2.89</b>	<b>3.34</b>
Pser		<b>1.08</b>	<b>1.24</b>	<b>1.10</b>	<b>1.26</b>	<b>1.11</b>	<b>1.28</b>	<b>1.13</b>	<b>1.30</b>	<b>1.15</b>	<b>1.33</b>	<b>1.16</b>	<b>1.34</b>
STUD HEIGHT (m)	2.5	<b>450</b>	<b>400</b>	<b>450</b>	<b>400</b>	<b>450</b>	<b>400</b>	<b>450</b>	<b>400</b>	<b>450</b>	<b>400</b>	<b>450</b>	<b>400</b>
	2.6	450	400	450	300	450	300	400	300	400	300	400	300
	2.7	400	300	400	300	400	300	400	300	300	300	300	300
	2.8	300	300	300	300	300	300	300	300	300	300	300	300
	2.9	300	300	300	N/A	300	N/A	300	N/A	300	N/A	300	N/A
	3.0	300	N/A	300	N/A	300	N/A	300	N/A	N/A	N/A	N/A	N/A
	3.1	300	300	300	N/A	300	N/A	300	N/A	300	N/A	300	N/A
	3.2	300	N/A	300	N/A	300	N/A	300	N/A	300	N/A	300	N/A

**NOTES:**

- Where the Stud spacing is specified as "N/A", contact a Rondo Technical Sales Representative.
- One (1) row of Nogging for wall heights up to and including 3.0m, two (2) rows of Nogging for wall heights over 3.0m high.

**RONDO DESIGN PARAMETERS:**

• 92 x 1.15mm BMT G2 Lipped Studs • Standard studs and tracks, with Slotted Deflection Head Tracks • Overall Building Height must be less than 21m.

**WIND LOADING PARAMETERS:**

VR = 60 m/s

Cpe = 0.8, -0.65

Cpi = -0.3, 0.2

KI=1.5 for General Wall areas in accordance with AS/NZS1170.2:2011 Cl 5.4.4

KI for Corner Zones as appropriate T5.6 (AS/NZS1170.2:2011)

Mz,cat assumed to vary with height

# WALL STUD DESIGN TABLES

Region B (continued)

TABLE 16: REGION B: TERRAIN CATEGORY 3 — H/360

		HEIGHT TO CENTRE OF WALL ABOVE "GROUND LEVEL" (m)											
		10		11		12		13		14		15	
ZONE		Gen	Cnr A	Gen	Cnr A	Gen	Cnr A	Gen	Cnr A	Gen	Cnr A	Gen	Cnr A
Pult		1.93	2.23	1.99	2.30	2.05	2.36	2.11	2.43	2.16	2.50	2.22	2.57
Pser		0.78	0.90	0.80	0.92	0.82	0.95	0.84	0.97	0.87	1.00	0.89	1.03
STUD HEIGHT (m)	2.5	600	600	600	450	600	450	600	450	600	450	600	450
	2.6	600	450	600	450	600	450	450	450	450	450	450	450
	2.7	450	450	450	450	450	450	450	450	450	450	450	400
	2.8	450	450	450	450	450	400	450	400	450	400	450	400
	2.9	450	400	450	400	450	300	400	300	400	300	400	300
	3.0	400	300	400	300	400	300	400	300	300	300	300	300
	3.1	450	300	400	300	400	300	400	300	400	300	300	300
	3.2	400	300	400	300	300	300	300	300	300	300	300	300

		HEIGHT TO CENTRE OF WALL ABOVE "GROUND LEVEL" (m)											
		16		17		18		19		20		21	
ZONE		Gen	Cnr A	Gen	Cnr A	Gen	Cnr A	Gen	Cnr A	Gen	Cnr A	Gen	Cnr A
Pult		2.27	2.62	2.33	2.68	2.38	2.74	2.43	2.80	2.48	2.86	2.51	2.90
Pser		0.91	1.05	0.93	1.08	0.95	1.10	0.97	1.12	1.00	1.15	1.01	1.16
STUD HEIGHT (m)	2.5	600	450	450	450	450	450	450	450	450	450	450	450
	2.6	450	450	450	450	450	450	450	400	450	400	450	400
	2.7	450	400	450	400	450	400	450	400	450	300	450	300
	2.8	450	300	400	300	400	300	400	300	400	300	400	300
	2.9	400	300	400	300	300	300	300	300	300	300	300	300
	3.0	300	300	300	300	300	300	300	300	300	N/A	300	N/A
	3.1	300	300	300	300	300	300	300	300	300	300	300	300
	3.2	300	300	300	N/A	300	N/A	300	N/A	300	N/A	300	N/A

**NOTES:**

- Where the Stud spacing is specified as "N/A", contact a Rondo Technical Sales Representative.
- One (1) row of Nogging for wall heights up to and including 3.0m, two (2) rows of Nogging for wall heights over 3.0m high.

**RONDO DESIGN PARAMETERS:**

• 92 x 1.15mm BMT G2 Lipped Studs • Standard studs and tracks, with Slotted Deflection Head Tracks • Overall Building Height must be less than 21m.

**WIND LOADING PARAMETERS:**

VR = 60 m/s

Cpe = 0.8, -0.65

Cpi = -0.3, 0.2

KI = 1.5 for General Wall areas in accordance with AS/NZS1170.2:2011 Cl 5.4.4

KI for Corner Zones as appropriate T5.6 (AS/NZS1170.2:2011)

Mz,cat assumed to vary with height

**TABLE 17: REGION B: TERRAIN CATEGORY 2.5 — H/360**

		HEIGHT TO CENTRE OF WALL ABOVE "GROUND LEVEL" (m)											
		10		11		12		13		14		15	
ZONE		Gen	Cnr A	Gen	Cnr A	Gen	Cnr A	Gen	Cnr A	Gen	Cnr A	Gen	Cnr A
Pult		<b>2.35</b>	<b>2.71</b>	<b>2.41</b>	<b>2.78</b>	<b>2.47</b>	<b>2.84</b>	<b>2.52</b>	<b>2.91</b>	<b>2.58</b>	<b>2.98</b>	<b>2.64</b>	<b>3.05</b>
Pser		<b>0.94</b>	<b>1.09</b>	<b>0.97</b>	<b>1.11</b>	<b>0.99</b>	<b>1.14</b>	<b>1.01</b>	<b>1.17</b>	<b>1.04</b>	<b>1.20</b>	<b>1.06</b>	<b>1.22</b>
STUD HEIGHT (m)	2.5	<b>450</b>	<b>450</b>	<b>450</b>	<b>450</b>	<b>450</b>	<b>450</b>	<b>450</b>	<b>450</b>	<b>450</b>	<b>450</b>	<b>450</b>	<b>450</b>
	2.6	450	450	450	400	450	400	450	400	450	400	450	400
	2.7	450	400	450	400	450	400	450	300	400	300	400	300
	2.8	400	300	400	300	400	300	400	300	400	300	300	300
	2.9	300	300	300	300	300	300	300	300	300	300	300	300
	3.0	300	300	300	300	300	300	300	N/A	300	N/A	300	N/A
	3.1	300	300	300	300	300	300	300	300	300	N/A	300	N/A
	3.2	300	N/A	300	N/A	300	N/A	300	N/A	300	N/A	300	N/A

		HEIGHT TO CENTRE OF WALL ABOVE "GROUND LEVEL" (m)											
		16		17		18		19		20		21	
ZONE		Gen	Cnr A	Gen	Cnr A	Gen	Cnr A	Gen	Cnr A	Gen	Cnr A	Gen	Cnr A
Pult		<b>2.69</b>	<b>3.10</b>	<b>2.73</b>	<b>3.15</b>	<b>2.77</b>	<b>3.20</b>	<b>2.82</b>	<b>3.25</b>	<b>2.86</b>	<b>3.31</b>	<b>2.89</b>	<b>3.34</b>
Pser		<b>1.08</b>	<b>1.24</b>	<b>1.10</b>	<b>1.26</b>	<b>1.11</b>	<b>1.28</b>	<b>1.13</b>	<b>1.30</b>	<b>1.15</b>	<b>1.33</b>	<b>1.16</b>	<b>1.34</b>
STUD HEIGHT (m)	2.5	<b>450</b>	<b>400</b>	<b>450</b>	<b>400</b>	<b>450</b>	<b>400</b>	<b>450</b>	<b>400</b>	<b>450</b>	<b>400</b>	<b>450</b>	<b>400</b>
	2.6	450	400	450	300	450	300	400	300	400	300	400	300
	2.7	400	300	400	300	400	300	400	300	300	300	300	300
	2.8	300	300	300	300	300	300	300	300	300	300	300	300
	2.9	300	300	300	N/A	300	N/A	300	N/A	300	N/A	300	N/A
	3.0	300	N/A	300	N/A	300	N/A	300	N/A	N/A	N/A	N/A	N/A
	3.1	300	N/A	300	N/A	300	N/A	300	N/A	300	N/A	300	N/A
	3.2	N/A	N/A	N/A	N/A	N/A	N/A	N/A	N/A	N/A	N/A	N/A	N/A

**NOTES:**

1. Where the Stud spacing is specified as "N/A", contact a Rondo Technical Sales Representative.
2. One (1) row of Nogging for wall heights up to and including 3.0m, two (2) rows of Nogging for wall heights over 3.0m high.

**RONDO DESIGN PARAMETERS:**

• 92 x 1.15mm BMT G2 Lipped Studs • Standard studs and tracks, with Slotted Deflection Head Tracks • Overall Building Height must be less than 21m.

**WIND LOADING PARAMETERS:**

VR = 60 m/s

Cpe = 0.8, -0.65

Cpi = -0.3, 0.2

KI=1.5 for General Wall areas in accordance with AS/NZS1170.2:2011 Cl 5.4.4

KI for Corner Zones as appropriate T5.6 (AS/NZS1170.2:2011)

Mz,cat assumed to vary with height

# MAXIJAMB DESIGN CHARTS

## How to use the charts

The MAXIjamb design charts have been presented in a graphical format, with coloured pressure lines providing the envelope within which the MAXIjamb is suitable. The opening framing requirements for each pressure may be determined by running a vertical line up the graph at the required wall height, then where it bisects the relevant coloured pressure line run a horizontal line left to determine the maximum opening.

The required coloured pressure line may be determined from the Wall Stud Design Tables.

Where an acceptable solution cannot be found within the table you will need to refer this back to your engineer, or alternatively to your Rondo Technical Representative.

### COMPARISON:

As a comparison between the MAXIjamb and using multiple studs, in the example shown the MAXIjamb stud may be used to frame a maximum window opening of say, 1950mm (see Figure 27).

Checking this against Table 9 on page 128 would require a minimum of three (3) 92 x 1.15bmt Lipped Studs to frame the opening.

Note that the stud spacing from the Wall Design Table indicates studs at 600mm centres are suitable. The MAXIjamb provides a considerable advantage over conventional framing.

27

		11	
ZONE		Gen	Cnr A
Pult		1.17	1.35
Pser		0.76	0.87
STUD HEIGHT (m)	2.5	600	600
	2.6	600	600
	2.7	600	600
	2.8	600	450
	2.9	450	450

1. Check the required pressure from the Wall Stud Design Tables to identify the appropriate coloured pressure line to use in the graph. (1.17kPa Pressure in this example)

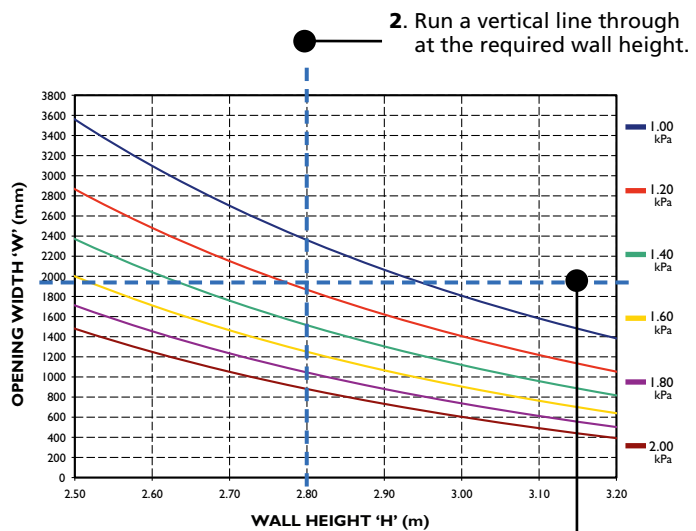

2. Run a vertical line through at the required wall height.

3. Run a horizontal line across where the vertical line bisects the required coloured pressure line.  
*Hint: Interpolate between pressure lines as required.*

4. Read off the maximum window opening at vertical axis intersection.  
*Say, 1950mm Maximum Opening.*

■ USING THE DEEIGN GRAPHS



# Jamb Stud Design: Region A

**CHART J1: DESIGN REGION A — H/240**

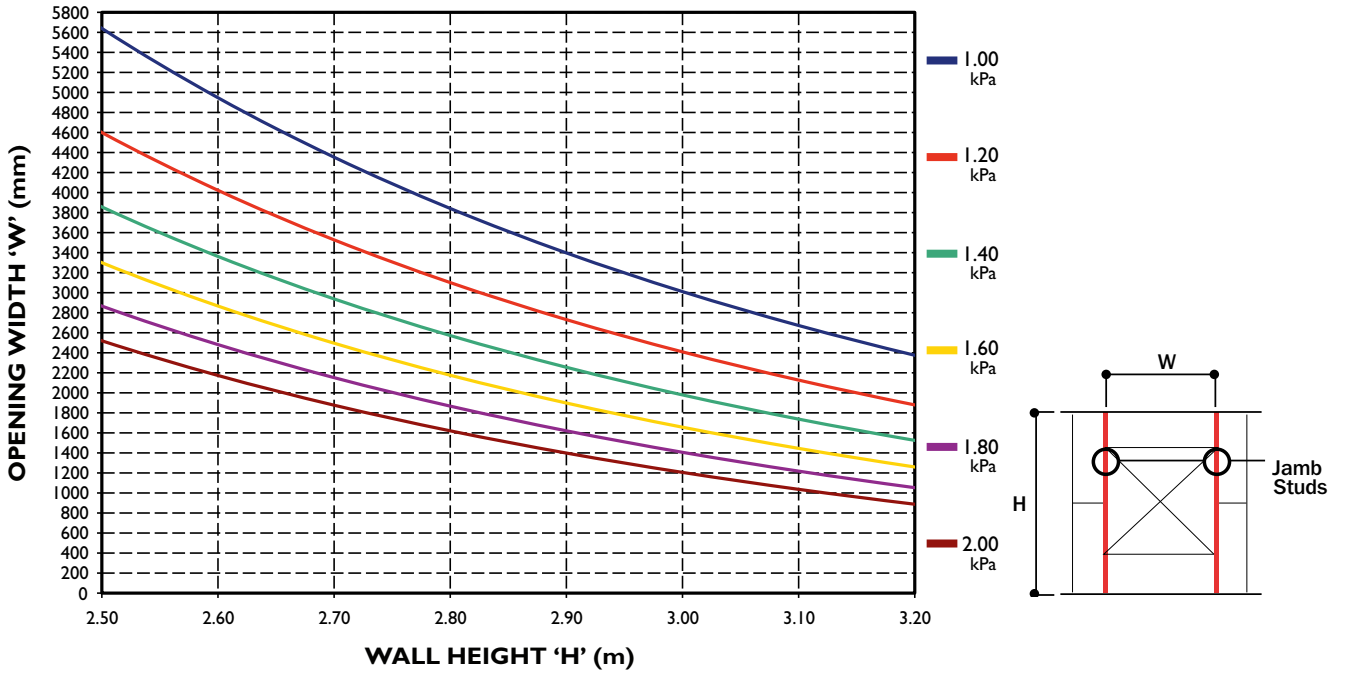

**CHART J2: DESIGN REGION A — H/360**

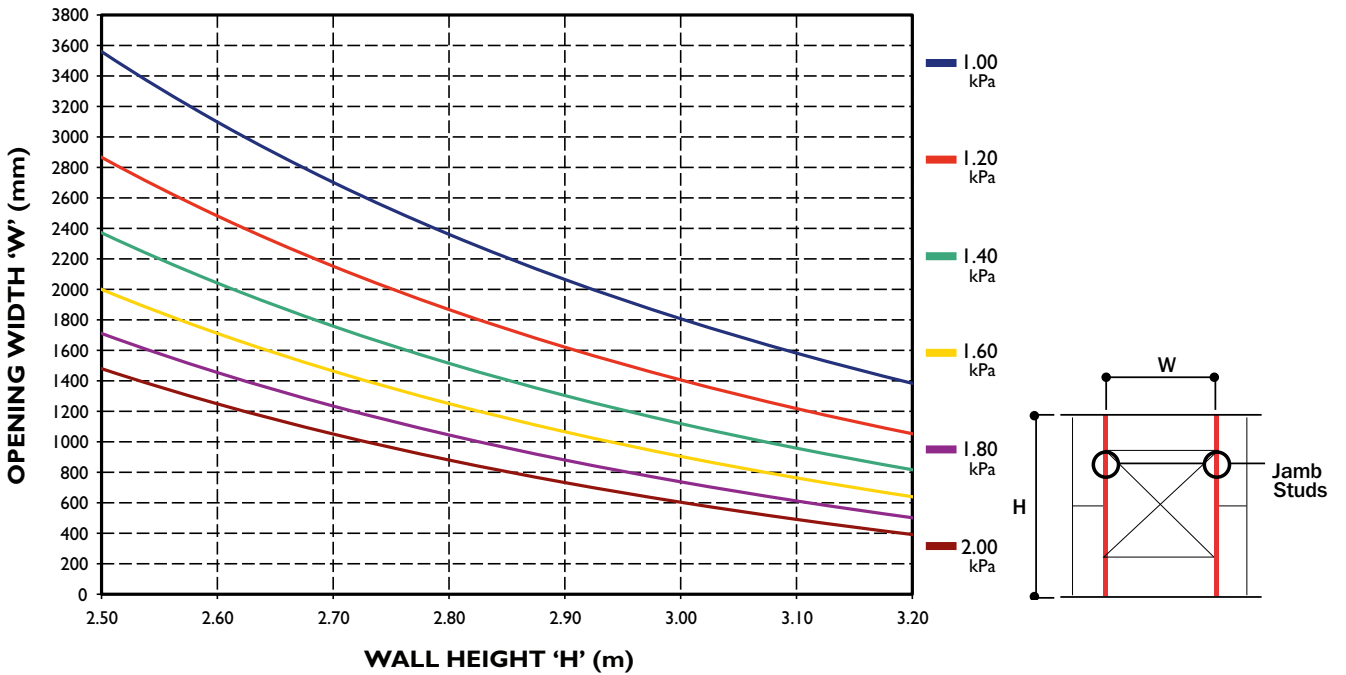

# MAXIJAMB DESIGN CHARTS (continued)

## Jamb Stud Design: Region B

CHART J3: DESIGN REGION B — H/240

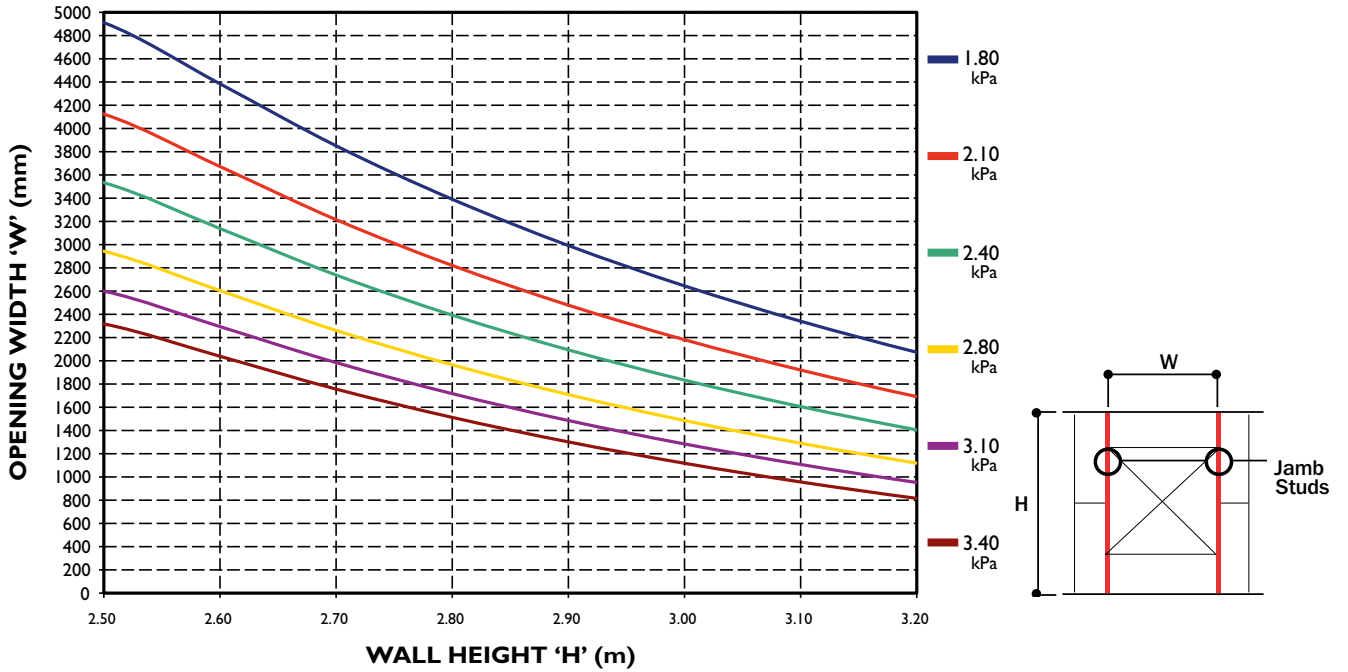
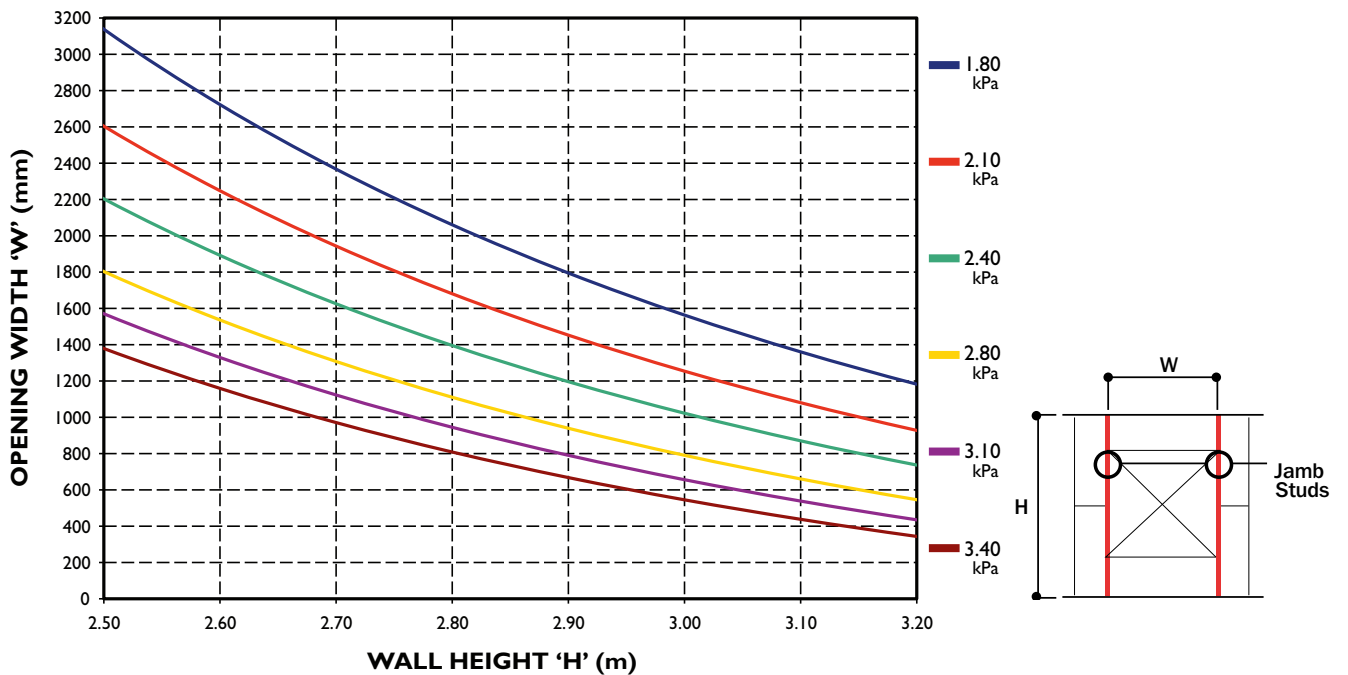

CHART J4: DESIGN REGION B — H/360



# MAXIJAMB SILL & HEADER FRAMING

The sill and header members are used to frame the window opening, such that they support and carry the wind loading applied across the window opening. The load carried by the sill and header member is significantly greater than that carried by the wall studs, as indicated by Figure 28.

The sill and header framing can be made up of a single wall track section or combination track and MAXIjamb horizontally. The combination framing is shown in Figure 29.

The tables and charts presented for the sill and header consider the above two framing options. Table 18 may be used for the single track section, and Charts SH1 to SH4 may be used to determine the maximum span for the MAXIjamb/track combination shown.

## WALL LOAD WIDTH (WLW)

Wall Track: WLW = 1200mm

MAXIjamb: WLW =  $\frac{\text{Wall Height (H)}}{2}$

## INTERPOLATION

Where the Wall Load Width (WLW) of the sill or header is other than specified, the maximum span of the track section may be estimated using a squared function interpolation as follows:

**New Span (mm) =**

$$\left\{ \frac{(\text{Tabulated span})^2 \times \text{WLW}}{\text{New WLW}} \right\}^{0.5}$$

## EXAMPLE:

Checking a wall track sill in Region A, for L/240 deflection limit, at 1.60kPa with a WLW = 1500mm

**New Span =**

$$\{ [1950]^2 \times 1200 / 1500 \}^{0.5} = 1740\text{mm}$$

Refer to Table 18 for span.

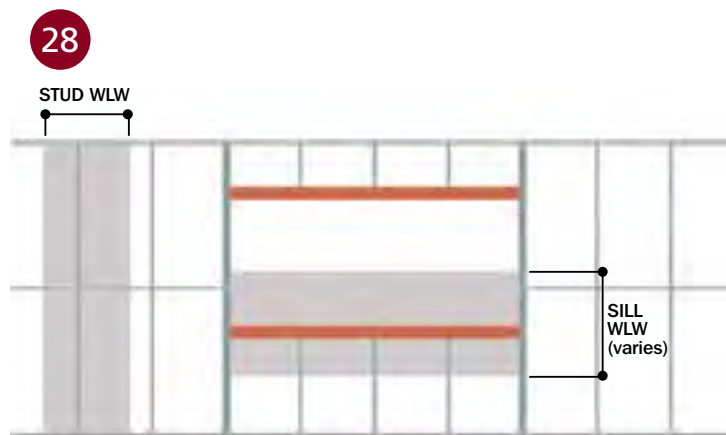

■ SILL & HEADER FRAMING DETAILS

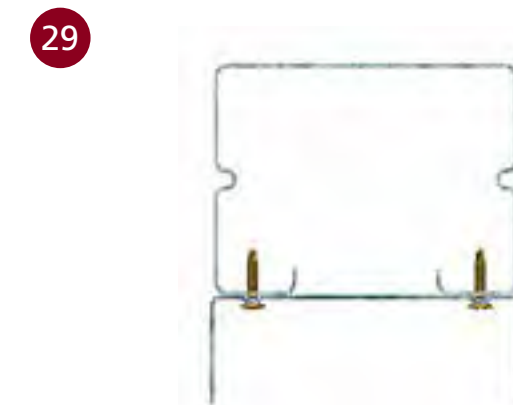

■ MAXIJAMB & TRACK COMBINATION SECTIONS

TABLE 18: MAXIMUM SPAN OF WALL TRACK (mm)

		ULTIMATE DESIGN PRESSURE (kPa)					
LOCATION	DEFLECTION LIMIT	1.00	1.20	1.40	1.60	1.80	2.00
REGION A	L/240	2500	2250	2100	1950	1850	1750
	L/360	2300	2150	2050	1950	1850	1750
		1.80	2.10	2.40	2.70	3.00	3.40
REGION B	L/240 & L/360	1850	1700	1600	1450	1300	1150

## NOTES:

1. The above table is based on a wall load width (WLW) of 1200mm.
2. The above table assumes a screwed stud and track fixing either end, similar to a wall stud base track connection.

# MAXIJAMB SILL & HEADER DESIGN

Region A

CHART SH1: H/240 (MAXIJAMB + 92 x 32 x 1.15BMT TRACK)

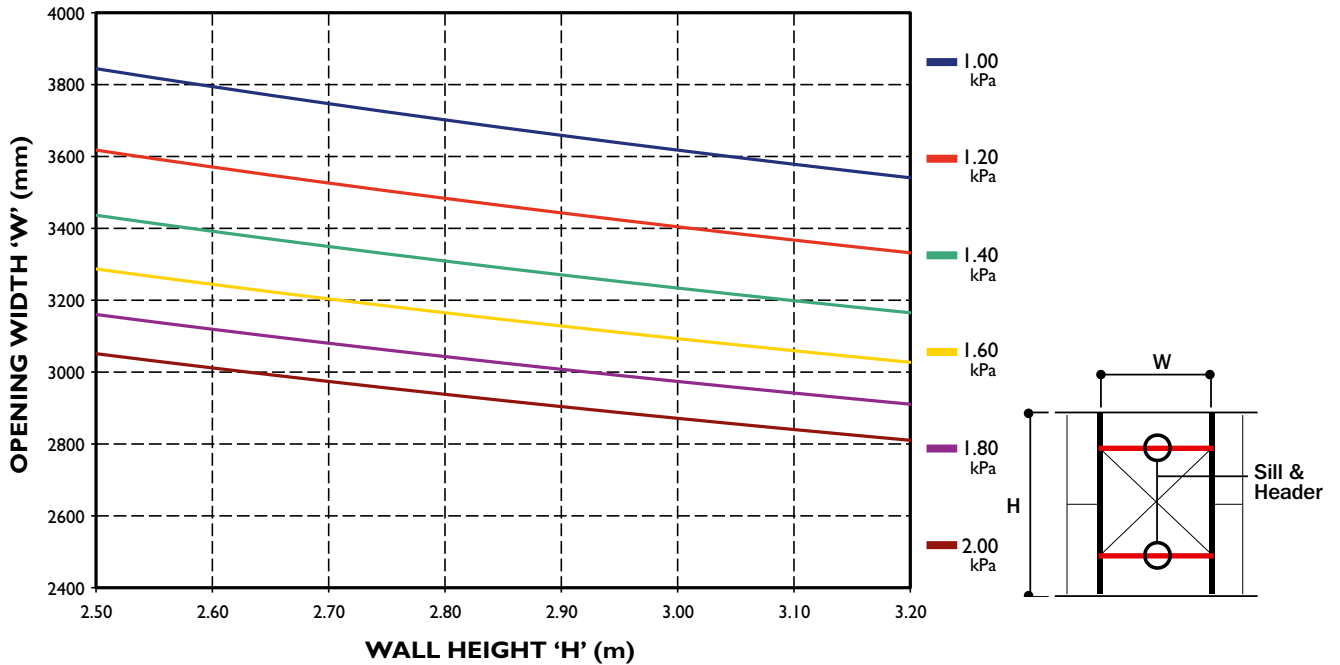
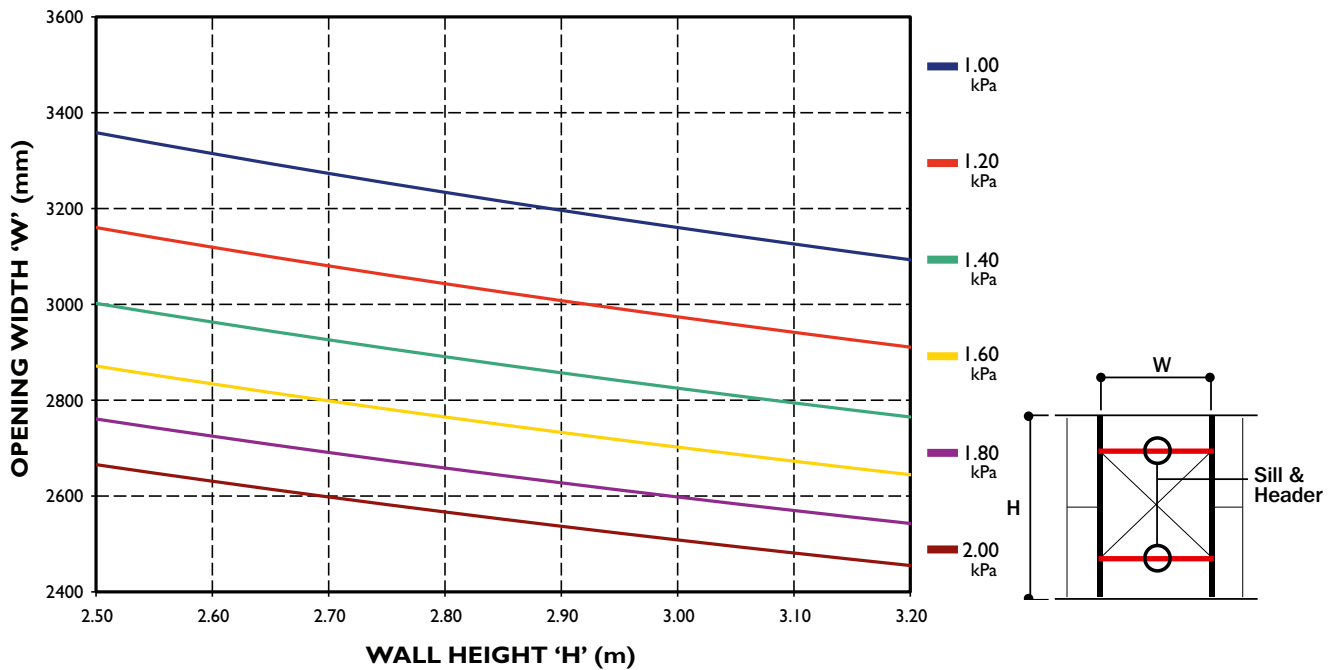
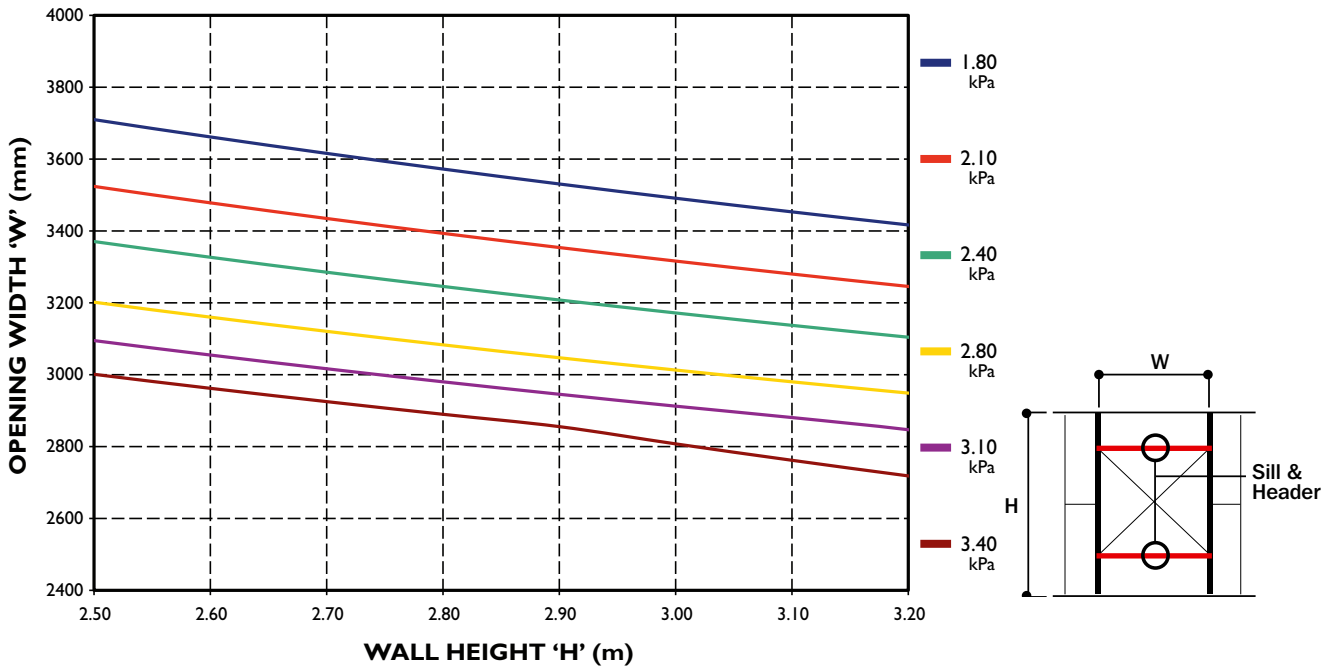

CHART SH2: H/360 (MAXIJAMB + 92 x 32 x 1.15BMT TRACK)



# Region B

**CHART SH3: H/240 (MAXIJAMB + 92 x 32 x 1.15BMT TRACK)**



**CHART SH4: H/360 (MAXIJAMB + 92 x 32 x 1.15BMT TRACK)**

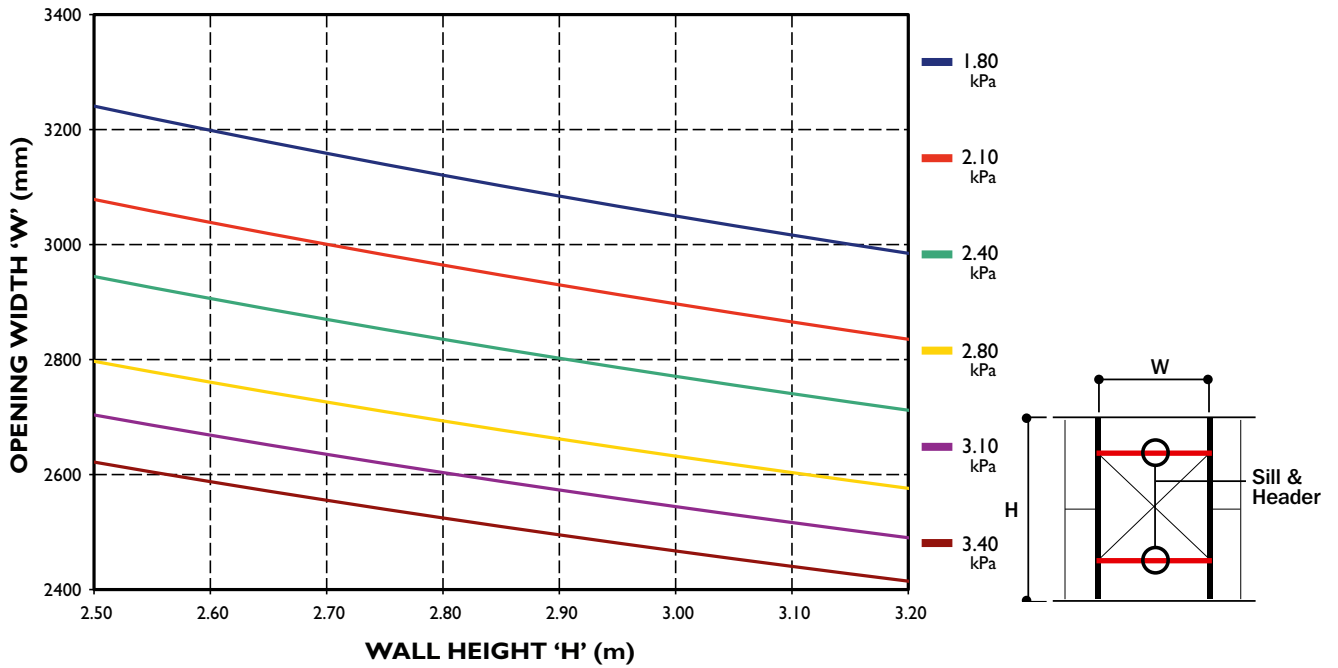

# ADDITIONAL INFORMATION

## Façade Cladding Systems

### TOP HATS

The use of top hat sections over steel stud framing frequently occurs, in particular for Metal Deck, CFC and Composite panel cladding systems. When the top hat is installed horizontally, across the face of the studs, Table 19 can be used to check the adequacy of the proposed top hat.

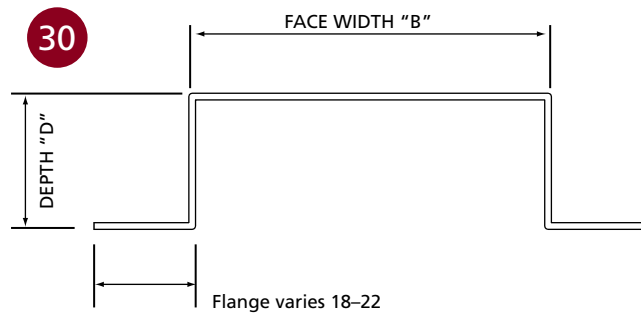

**Part No. H515**

H Indicates thickness = 1.15bmt gauge  
 5 Indicates face width B = 50mm face width  
 15 Indicates section depth D = 15mm depth

■ TOP HAT SECTION

### AUTOCLAVED AERATED CONCRETE PANELS

The stud framing design tables and charts presented in this manual have been prepared on the basis of a vented façade, with both internal and external pressures considered. Accordingly, the design data may be used for the design of stud framing clad with AAC Panels. For AAC Panels construction Rondo recommends that the AAC Panels bear on either the floor slab or a shelf angle. The stud framing has not been checked to support the weight of the AAC panels.

### METAL DECK CLADDING

The stud framing design tables and charts presented in this manual can be used to check framing supporting metal deck cladding. Rondo recommends using the H/240 span tables for these applications, as the cladding is flexible enough to tolerate the reduced deflection limits.

**TABLE 19: TOP HAT ULTIMATE CAPACITY (kPa)**

TOP HAT SECTION	600mm SPACING SINGLE SPAN	600mm SPACING CONTINUOUS
H515	2.15	3.40*
H525	7.60	3.40*
H535	8.50*	3.40*
H550	8.50*	3.40*
H715	2.50	3.40*
H725	8.50*	3.40*
H735	8.50*	3.40*
H750	8.50*	3.40*

**NOTES:**

1. Maximum span of top hats not to exceed 600mm typical.
2. Deflection:  $L / 360$  or better.
3. Fixing 1/#10 tek screw per leg per stud typical. Pullout capacity  $N_{ou} = 1.54kN$ , based on 1.15bmt G2 grade steel.
4. "\*" indicates connection capacity controls.

### BRICK VENEER

Brick veneer is probably the most common form of construction, and the H/360 tables in this manual can be used to check the stud framing. Whilst many people use higher deflection than H/360, over many years, this has been found to be sufficient for this form of construction.

Quite often the external wall will be “wrapped” to improve the thermal efficiency of the wall, and this will necessitate a face fixing of the brick tie. Face fixing of the brick ties results in the screw fixing being pulled out of the stud framing under negative pressures on the wall. Table 20 provides the maximum design pressures for the given brick tie setout.

When stainless steel brick ties are used, they are to be electrolytically isolated from the galvanized steel framing members. The screw fasteners shall be selected in accordance with the manufacturer’s recommendations; however Rondo does not recommend the use of stainless steel fasteners in direct contact with the frame.

Brick ties should be installed to minimise the eccentricity, by ensuring the brick tie is screw fixed as close as possible to the web of the stud.

**TABLE 20: DESIGN PRESSURES**

	DESIGN PRESSURE (kPa)	
	STUD SPACING (mm)	
VERTICAL TIE SPACING (mm)	450	600
450	3.82	2.86
600	2.86	2.15

**NOTES:**

1. Screw fastener: 1/#8 tek screw.
2. Design pressure is based on a single #8 tek screw fastener. Capacity may be increased for multiple fasteners.



# DERIVATION OF THE DESIGN PRESSURES

The design pressures used in these tables have been determined in accordance with AS/NZS1170.2:2002 as follows:

## BUILDING IMPORTANCE LEVEL

The designer is responsible for checking the building importance level in accordance with the Building Code of Australia (BCA) Section B. The building importance level dictates the annual probability of exceedance and subsequently the appropriate Regional Wind Speed ( $V_R$ ).

For the design tables, a Regional Wind Speed of  $V_{1000}$  has been used, which equates to a Building Importance Level 3. This will be conservative for a building of Importance Level 2, with about a 4.5% and 8% difference in the Ultimate design pressure for Regions A and B respectively.

For buildings of Importance Level 4 a specific design will be required, and this should be discussed with your Rondo Technical Representative.

## DESIGN WIND SPEED

The Design Site Wind Speed is determined as follows:

$$V_{\text{sit},\beta} = V_R M_d (M_{z,\text{cat}} M_s M_t) \quad \dots \mathbf{2.2}$$

Where:

$M_d = 1$  Directionality has not been considered  
For Region A, the value of  $M_d$  can vary between 0.8 to 1.0 depending on the orientation of the building. In Region B, the value of  $M_d$  is 1.0. Accordingly, the use of  $M_d = 1$  will be correct in Region B, or potentially conservative in Region A.

$M_s = 1$  Shielding has not been considered

$M_t = 1$  Topography has not been considered

The designer should be aware that an assumption of  $M_t = 1$  is not necessarily a conservative solution. Accordingly, the designer should check the topographical multiplier  $M_t$  in accordance with AS/NZS1170.2 before using the design tables.

$M_{z,\text{cat}}$  Varies with Terrain category and building height

The design site wind speed is therefore taken as:

$$V_{\text{des},\theta} = V_R M_{z,\text{cat}}$$

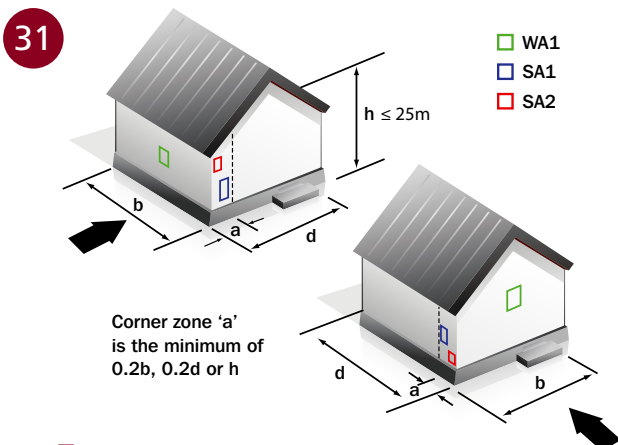

LOCAL PRESSURE ZONES

## DESIGN WIND PRESSURE

The Design Wind Pressure ( $p$ ) is determined as follows:

$$p = (0.5 \rho_{\text{air}}) [V_{\text{des},\theta}]^2 C_{\text{fig}} C_{\text{dyn}} \quad \dots \mathbf{2.4(1)}$$

Where:

$$\rho_{\text{air}} = 1.2 \text{ kg/m}^3$$

$$C_{\text{dyn}} = 1$$

$C_{\text{fig}} =$  Varies depending on location on building

Thus equation 2.4(1) can be simplified to:

$$p = 0.6 [V_{\text{des},\theta}]^2 C_{\text{fig}}$$

The tables have been presented in terms of General Areas (Gen) and Corner A (Cnr A) which relate to the following locations on the building:

Gen = Windward wall location beyond the corner zones

WA1 wall areas per Figure 21

Cnr A = Zone within 0.5a of the building corner, for buildings less than 25m high

SA2 wall areas per Figure 21

## $C_{\text{fig}}$ – General Areas

For the General Areas,  $C_{\text{fig}}$  has been determined as follows:

$$C_{\text{fig}} = [C_{\text{pe}} K_f - C_{\text{pi}}]$$

Where:

$C_{\text{pe}} = +0.8$  AS/NZS1170.2 Table 5.2(A)  
Wind speed varies with height

$K_f = 1.5$  AS/NZS1170.2 Table 5.6 for WA1

$C_{\text{pi}} = -0.3$  AS/NZS1170.2 Table 5.1(A)  
Windward wall permeable, or all walls equally permeable.

Façade permeability has been considered for the building internal pressures. The tables may not be valid for buildings containing dominant openings, which should be independently considered by the designer.

For the windward wall case,  $C_{\text{fig}} = \mathbf{1.5}$

## $C_{\text{fig}}$ – Corner Zone A

For the Corner Zone A,  $C_{\text{fig}}$  has been determined as follows:

$$C_{\text{fig}} = [C_{\text{pe}} K_f - C_{\text{pi}}]$$

Where:

$C_{\text{pe}} = -0.65$  AS/NZS1170.2 Table 5.2(C)

$K_f = 2.00$  AS/NZS1170.2 Table 5.6 for SA2, corresponding to Cnr A table

$C_{\text{pi}} = +0.2$  AS/NZS1170.2 Table 5.1(A)  
Windward wall permeable, or all walls equally permeable.

Façade permeability has been considered for the building internal pressures. The tables may not be valid for buildings containing dominant openings, which should be independently considered by the designer.

For the Cnr A wall case,  $C_{\text{fig}} = \mathbf{1.50}$

# DERIVATION OF THE DESIGN CAPACITIES

## SECTION MOMENT CAPACITY

$$\phi_b M_{sx} = \phi_b Z_{ex} f_y \quad \dots 3.3.2.2$$

Where:

$$\phi_b = 0.95$$

$Z_{ex}$  = the effective section modulus with the extreme compression or tension fibre at  $f_y$

$f_y$  = yield stress of the steel

## MEMBER MOMENT CAPACITY

$$\phi_b M_{bx} = \phi_b Z_c f_c \quad \dots 3.3.3.2(1) \text{ or } 3.3.3.3(1) \text{ respectively}$$

Where:

$$\phi_b = 0.90$$

$Z_c$  = the effective section modulus with the extreme compression fibre at  $f_c$

$$f_c = M_c / Z_f$$

$M_c$  = the critical moment

$Z_f$  = the full unreduced section modulus for the extreme compression fibre.

### Member Moment Capacity – Flexural Torsional Buckling

$$\phi_b M_b = \phi_b Z_c f_c \quad \dots 3.3.3.2(1)$$

The critical moment  $M_c$  is calculated as follows:

$$\begin{aligned} \text{For } \lambda_b \leq 0.60: & \quad M_c = M_y \\ \text{For } 0.60 < \lambda_b < 1.336 & \quad M_c = 1.11 M_y [1 - (10 \lambda_b^2) / 36] \end{aligned}$$

$$\text{For } \lambda_b \leq 1.336 \quad M_c = M_y (1 / \lambda_b^2)$$

$\lambda_b$  = Non-dimensional slenderness ratio used to determine  $M_c$   
 $= \sqrt{M_y / M_o}$

$M_o$  = elastic buckling moment  
 Calculated by the flexural torsional buckling analysis software

### Member Moment Capacity – Distortional Buckling

$$\phi_b M_b = \phi_b Z_c f_c \quad \dots 3.3.3.3(1)$$

The critical moment  $M_c$  is calculated as follows:

$$\begin{aligned} \text{For } \lambda_d \leq 0.674: & \quad M_c = M_y \\ \text{For } \lambda_d > 0.674: & \quad M_c = M_y / \lambda_d [1 - (0.22 / \lambda_d)] \end{aligned}$$

$\lambda_d$  = Non-dimensional slenderness ratio used to determine  $M_c$   
 $= \sqrt{M_y / M_{od}}$

$M_{od}$  = distortional buckling moment  
 $= Z_f f_{od}$

$f_{od}$  = elastic distortional buckling stress  
 Calculated in accordance with AS/NZS4600 Appendix D or Thinwall

## SHEAR CAPACITY

$$\phi_v V_v = \phi_v 0.64 t_w^2 \sqrt{E} k_v f_y \quad \dots 3.3.4(2)$$

for the wall stud sections

$$= \phi_v \frac{0.905E k_v t_w^3}{d_1} \quad \dots 3.3.4(3)$$

for the MAXIjamb sections

Where:

$$\phi_v = 0.90$$

$$k_v = 5.34$$

$$d_1/t_w = 73.93 \text{ for the } 92 \times 1.15 \text{ BMT sections}$$

$$= 69.75 \text{ for the MAXIjamb section}$$

The web ribbing has been ignored in the shear capacity determination, and  $d_1$  has been taken as the width of the stud less material thickness and internal bend radii.

## COMBINED MOMENT & SHEAR CAPACITY

$$\left( \frac{M^*}{\phi M_s} \right)^2 + \left( \frac{V^*}{\phi V_v} \right)^2 \leq 1.0$$

Bending and shear is checked at all points along the stud.